

2016

TECH CELL

SINUS

ERGUS

INVERTERS



ERGUS INVERTERS

Dal 1993 l'innovazione
100% Made in Italy
al tuo servizio.
Ergus: potenza e perfezione.

Since 1993 100% Made
in Italy innovation for you.
Ergus: Power and Perfection.

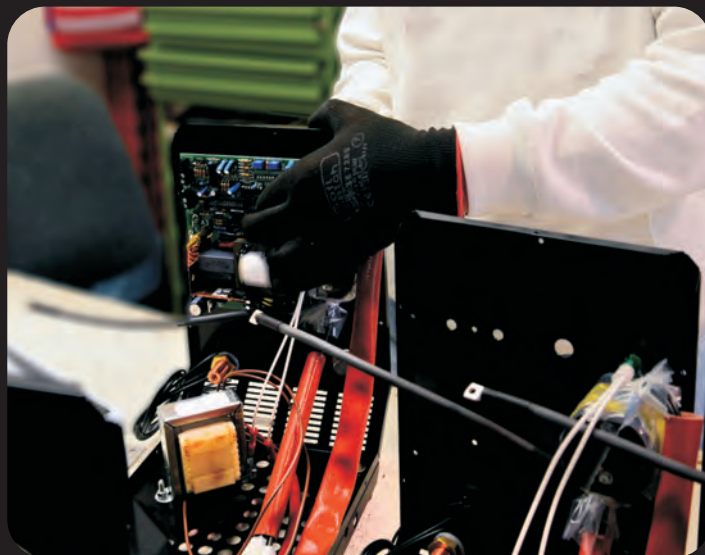

Sistemi di Certificazione
Certification System



EN 60974-1
EN 60974-10



Tutte le indicazioni riportate in questo catalogo sono a mero scopo indicativo e non vincolante, fatti salvi e riservati tutti i diritti di proprietà industriale, di esclusività dei marchi depositati e dell'immagine dell'azienda e dei prodotti. Il presente catalogo è di proprietà della TEC.LA. Srl e non può essere riprodotto in tutto o in parte senza espressa autorizzazione.



















The properties declared herein have only the value of technical information and do not involve the liability of the manufacture. All rights reserved on industrial property, corporate name, image and products. This general catalogues is property of TEC.LA Srl. Full or partial reproduction is not allowed without authorization.

INVERTERS

Identità • Identity

	Saldatura ad Elettrodo Electrode Welding
	Saldatura TIG TIG Welding (GTAW)
	Saldatura a Filo (MIG) MIG Welding (GMAW)
	Taglio Plasma Air Plasma Cutting
	Corrente Continua Direct Current
	Corrente Alternata Alternating Current
	Innesco a Striscio (Scratch) Scratch Ignition
	Innesco Lift Lift Arc Ignition
	Accessori Accessories
	Alimentazione Monofase Single Phase Input
	Alimentazione Trifase Three Phase Input
	Antincollaggio Antisticking
	Grado di protezione Protection Class

Caratteristiche • Features

	Antincollaggio Antisticking		Pulsato Pulser
	Elettrodo alluminio Alluminium Electrode		Innesco Lift Lift Arc Ignition
	Elettrodo cellulosico Cellulosic Electrode		Innesco alta frequenza High Frequency Ignition
	Peso Weight		Arco pilota Pilot Arc
	Diametro basilco Ø Basic		Capacità di taglio Cutting Performance
	Adatto per motogeneratori Use for Motor Generator		Grado di protezione Protection Class
	Pannello digitale Display		Garanzia Warranty
	Memorizzazione programmi Program Memory		TIG alluminio Alluminium TIG
	Filo animato Flux Core Wire		PFC Series SINUS PFC Series SINUS



Questo dato indica il ciclo di lavoro in percentuale in un tempo di lavorazione di 10 minuti. Es. 140 A - 60% = 6/10 minuti: l'inverter può saldare con una corrente di 140 A per un tempo di 6 minuti su 10, cioè il 60%; nel rimanente tempo, 40 % o 4 minuti, il generatore non dovrà saldare per permettere un adeguato raffreddamento. Successivamente si potranno ripetere altri cicli di lavoro. I generatori Ergus sono studiati per essere utilizzati in ambito industriale grazie a un "Duty Cycle" molto elevato; il nome stesso dell'inverter rispecchia la reale corrente disponibile.

Duty Cycle - The number of minutes out of a 10-minute time period an arc welding machine can be operated at maximum rated output. Ergus inverters are power sources mainly for industrial use. The duty cycle, expressed as a percentage, is indicated besides each ERGUS model. An example is E 141 DCi with 60% duty cycle. This means that at 140 amps this inverter can be used for 6 minutes and then must be allowed to cool under forced ventilation for 4 minutes. Then the cycle starts again.

Ergus Inverters: potenza che eclissa

Ergus Inverters: Power Wins Over the Eclipse

Arriva la nuova serie di generatori Ergus ad inverter per la saldatura e il taglio con procedimenti ad Elettrodo, TIG DC, TIG AC/DC, MIG e TAGLIO PLASMA: garantiscono la perfetta saldatura e il taglio di tutti i tipi di materiali conduttori. Questo è possibile grazie alla dinamica innovativa dell'inverter: si tratta di un particolare circuito oscillante che, ricevendo in ingresso una tensione continua, fornisce una corrente alternata alla frequenza voluta.

I vantaggi sono evidenti: le saldatrici ad inverter, diversamente da quelle convenzionali, permettono di aumentare la frequenza di lavoro e di ottenere:

- utilizzo di trasformatori e induttanze di dimensioni molto più piccole, quindi più leggere.
- rapidissime variazioni della corrente di saldatura o di taglio.
- regolazione istantanea della corrente, per adeguarla al processo di saldatura.
- ottimo innesco e stabilità dell'arco anche a correnti minime, ottenute tramite il sistema a modulazione di larghezza di impulso.
- arco stabile anche con fluttuazioni della tensione di alimentazione +/- 10% o variazioni nel movimento della torcia.
- notevole risparmio energetico, con riduzioni di circa 1/3 della potenza assorbita rispetto alle saldatrici convenzionali.

VANTAGGI INNOVATIVI

Il nuovo sistema di controllo ad inverter riduce le dimensioni e gli assorbimenti di energia. Ecco come:

- la frequenza di funzionamento degli inverter ERGUS è da 50 a 100 kHz

- il veloce sistema di retroazione PWM permette il controllo dell'arco di saldatura più di 1,000 volte/sec.

Si ottengono così un arco estremamente stabile ed un innesco perfetto.

Introducing the new ERGUS inverter power sources for arc welding and cutting! Presenting MMA, TIG DC, TIG AC/DC, Portable MIG, and PLASMA cutting. These machines ensure a smooth and perfect performance with all metals. Thanks to the inverter's innovative dynamic oscillating concept, direct current is continuously transformed into controlled alternating current, with subsequent advantage of increased working frequency, and therefore:

*smaller and lighter choke and transformers
easily adjustable welding parameters
excellent arc ignition and stability at low and high output power settings, thanks to wider welding impulse control.*

- smaller and lighter choke and transformers
- easily adjustable welding parameters
- excellent arc ignition and stability at low and high output power settings, thanks to wider welding impulse control.
- arc stability even under +/- 10% mains input variations, or sudden torch movements
- high energy saving - about 1/3 versus traditional power sources.

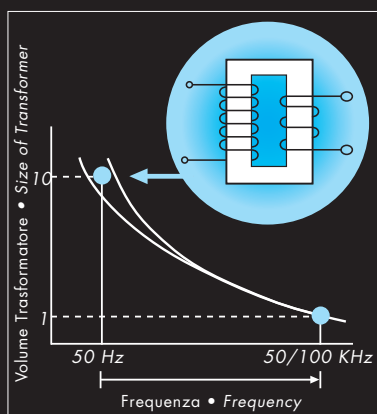

INNOVATIVE ADVANTAGE

With ERGUS inverters energy saving and reduced size is obtained thanks to:

- operating frequency between 50 and 100 KHz
- feed-back PWM system allows a 1000 times/sec arc control, ensuring stability and smooth ignition in all working conditions.

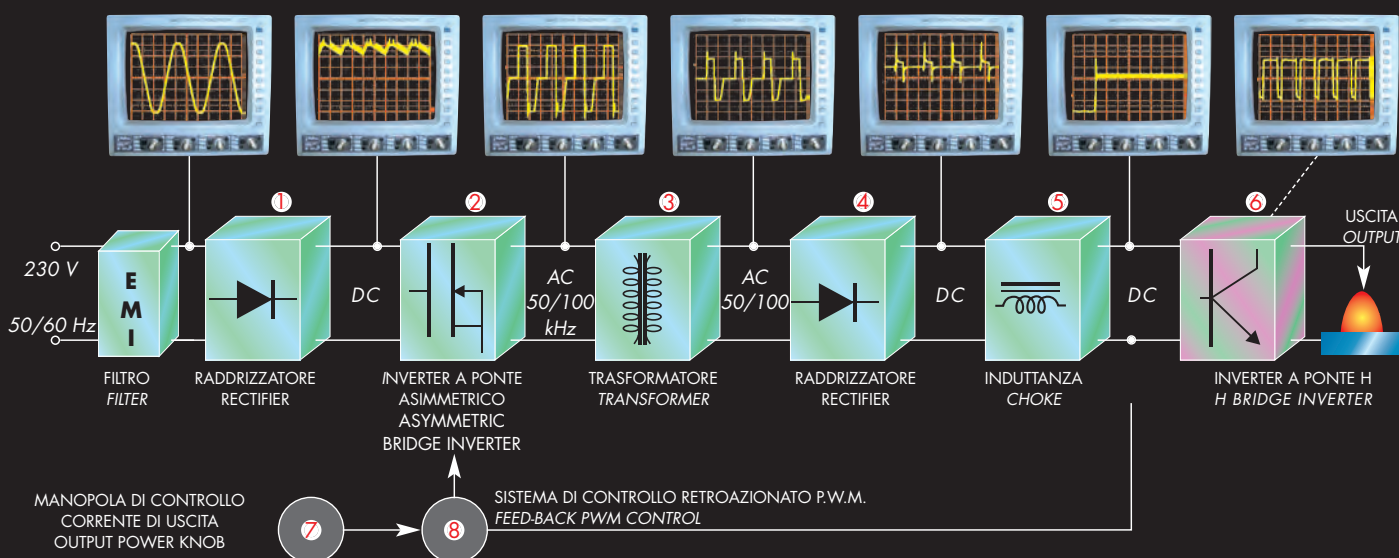



MMA **OTECH** CELL

da pag 7 a pag 16 - Accessori pag 17
from page 7 to 16 - Accessories pag 17



TIG DC

da pag 19 a pag 23 - Accessori pag 28
from page 19 to 23 - Accessories pag 28



TIG AC/DC

da pag 25 a pag 27 - Accessori pag 28
from page 25 to 27 - Accessories pag 28



MIG / MAG

da pag 30 a pag 35 - Accessori pag 36
from page 30 to 35 - Accessories pag 36



PLASMA CUTTING

da pag 38 a pag 44
from page 38 to 44



PFC **SINUS**

da pag 46 a pag 49 - Accessori pag 17
from page 46 to 49 - Accessories pag 17

LA SALDATURA AD ELETTRODO

È uno dei procedimenti più utilizzati: la saldatura avviene grazie alla formazione di un arco elettrico (detto arco di saldatura) che si innesca tra un elettrodo e il pezzo da saldare. Il calore prodotto dall'arco di saldatura fonde sia l'elettrodo, trasformandosi in gocce di metallo, che il materiale base. La fusione necessita della protezione dall'ossidazione dell'aria; durante la saldatura viene quindi protetta tramite il gas che si sviluppa dalla fusione del rivestimento dell'elettrodo e, durante il raffreddamento, per mezzo della scoria che verrà successivamente rimossa. Il rivestimento può essere di tipo RUTILE, ACIDO, BASICO e CELLULOSICO.

Il rivestimento dell'elettrodo influisce:

- Sulla stabilità dell'arco, ossia sul regolare funzionamento di quest'ultimo;
- Sulla composizione chimica e sulle proprietà meccaniche del deposito;
- Sulle condizioni di lavoro.

VANTAGGI

- In corrente continua la saldatura risulta molto stabile e uniforme, consentendo di operare anche a bassi valori e in posizioni difficili. Il range della corrente e la polarità di saldatura relativa al tipo di elettrodo impiegato viene specificato dal costruttore sul contenitore degli elettrodi stessi.
- Il generatore ad elettrodo, con gli accessori adeguati come la torcia TIG con valvola e il riduttore di pressione, permette la saldatura in TIG con innesco SCRATCH e, nei generatori più evoluti, la saldatura TIG con innesco LIFT.

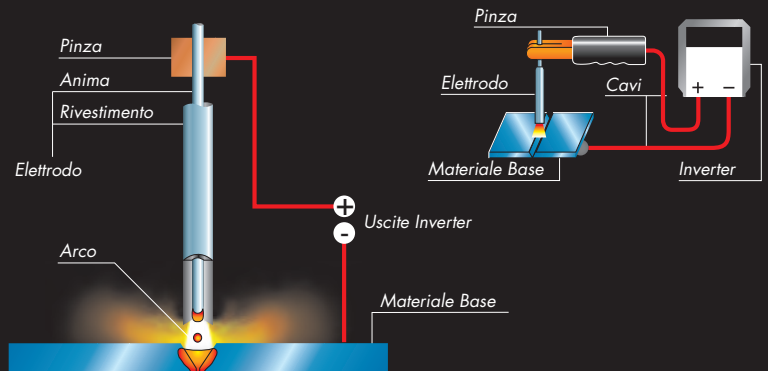

TIPO DI RIVESTIMENTO	PROPRIETÀ	POSIZIONI D'IMPIEGO	UTILIZZO	CARATTERISTICHE
RUTILE	Arco molto stabile	Tutte le posizioni	Non adatto per acciai di elevati spessori	Scoria molto consistente; facilità di impiego; penetrazione scarsa
ACIDO	Arco stabile; buone proprietà meccaniche; alta velocità di fusione	Piano	Non adatto per acciai di elevati spessori	Buona penetrazione, scoria abbondante, facilità di impiego
BASICO	Ottime proprietà meccaniche	Tutte le posizioni	Adatto per forti spessori e per giunti molto vincolanti	Impiego impegnativo conservazione delicata
CELLULOSO	Elevata penetrazione; buone proprietà meccaniche del deposito	In tutte le posizione	Prima passata sui tubi; non adatto per acciaio di elevato spessore	Scoria scarsa

STICK ELECTRODE WELDING

This is a very common welding process. The welding arc is formed between the welding electrode (stick) and the work-piece. The high temperature of the arc melts the electrode and the base metal, while welding is taking place. The weld metal needs to be shielded from environmental oxygen. During welding, this shield is created by the smoke generated from the electrode coating. During cooling, the shield is guaranteed by the bead slag. Then, the slag is removed. Electrode coating can be of several types: Rutile, Acid, Basic and Cellulose.

- Coating is important for:
Arc stability during welding;
- Metallic composition and features of the welding bead;
- Welding quality and job results.

ADVANTAGES

- DC welding is extremely stable and seam is regular, both at low current and with unusual positions. The choice of electrodes and of inverter connectors polarity depends on the single job and is indicated on the electrodes' package.
- TIG welding is possible by using a proper TIG torch and gas pressure gauge. TIG ignition will be SCRATCH, unless with the higher positioned models, where ignition is LIFT.

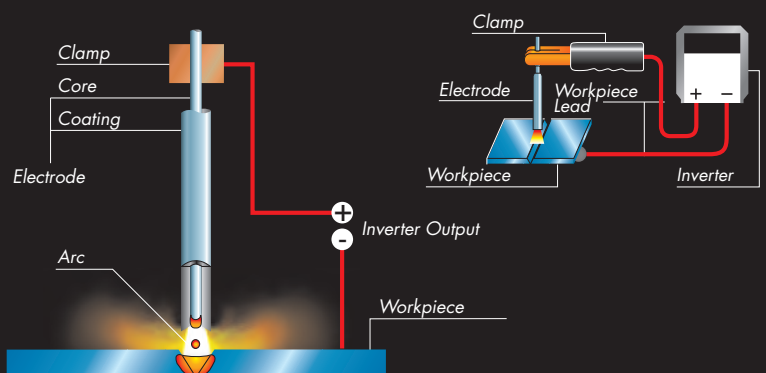

COATING	FEATURES	WELDING POSITION	USE	PERFORMANCE
RUTILE	Very stable welding arc	All positions	Not suitable for thick steel	Much slug; easy to use; low penetration
ACID	Stable arc	Slow	Not suitable for thick steel	Good penetration; much slug; easy to use
BASIC	Good strength	All positions	Suitable for thick material and thick joints	Professional jobs; care demanding storage
CELLULOSIC	Deep penetration; good strength	All positions	Round pipe welding; not suitable for thick steel	Little slug

ADV SERIES

INVERT 140/40 SL G-PROT

DDF115.140.T-E.06.00



MMA TECH-CELL

CE

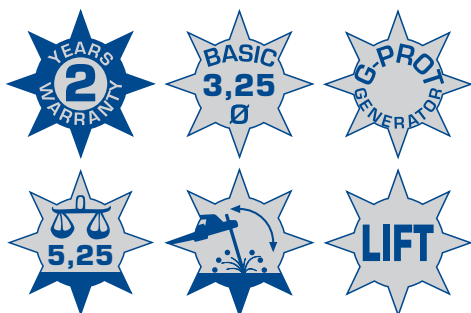

PROCESSI / DUTY

Ciclo di lavoro TIG DC • TIG DC duty cycle	140 A – 50%
Corrente al 100 % • TIG DC output at 100% duty cycle	100 A
Ciclo di lavoro elettrodo • Electrode duty cycle	140 A – 40%
Corrente al 100 % • Electrode output at 100% duty cycle	90 A

INVERTER

Tensione di alimentazione • Mains voltage	230V ±10%
Frequenza • Frequency	50/60Hz
Tensione a vuoto • OCV	95 V
Potenza nominale elettrodo 100% • Electrode Nominal Power 100%	2,6 KW
Potenza nominale TIG DC 100% • TIG DC Nominal Power 100%	1,7 KW
Tensione d'arco elettrodo • Electrode arc voltage	20,2 – 25,6 V
Tensione d'arco TIG • TIG arc voltage	10,2 – 15,6 V
Corrente max • Max current	23 A
Fusibile di protezione • Protective Fuses	time lag 16 A ritardato
Fattore di potenza • Power factor	0,85
Grado di protezione • Degree of protection	IP 21 S
Classe d'isolamento • Insulation Class	F
Temperatura ambiente • Working temperature	-10°C+40°C
Dimensioni (mm) • Size (mm)	250x130x220
Peso (Kg) • Weight (Kg)	5,25

FUNZIONI / FEATURES

Campo di regolazione elettrodo • Electrode output range	5 – 140 A
Campo di regolazione TIG DC • TIG DC output range	5 – 140 A
Hot start • Hot start	Automatic
Arc force • Arc force	Automatic
Anti incollaggio • Antisticking	Automatic
Tipo innesco TIG DC • Type of arc ignition	LIFT ARC

ADV SERIES

INVERT 150/40 SL G-PROT

DDF115.150.T-E.01.00



CE



PROCESSI / DUTY

Ciclo di lavoro TIG DC • TIG DC duty cycle	150 A – 50%
Corrente al 100 % • TIG DC output at 100% duty cycle	105 A
Ciclo di lavoro elettrodo • Electrode duty cycle	150 A – 40%
Corrente al 100 % • Electrode output at 100% duty cycle	95 A

INVERTER

Tensione di alimentazione • Mains voltage	230V ±10%
Frequenza • Frequency	50/60Hz
Tensione a vuoto • OCV	95 V
Potenza nominale elettrodo 100% • Electrode Nominal Power 100%	2,8 KW
Potenza nominale TIG DC 100% • TIG DC Nominal Power 100%	1,9 KW
Tensione d'arco elettrodo • Electrode arc voltage	20,2 – 26 V
Tensione d'arco TIG • TIG arc voltage	10,2 – 16 V
Corrente max • Max current	25 A
Fusibile di protezione • Protective Fuses	time lag 16 A ritardato
Fattore di potenza • Power factor	0,85
Grado di protezione • Degree of protection	IP 23 S
Classe d'isolamento • Insulation Class	F
Temperatura ambiente • Working temperature	-10°C+40°C
Dimensioni (mm) • Size (mm)	285x155x220
Peso (Kg) • Weight (Kg)	6,05

FUNZIONI / FEATURES

Campo di regolazione elettrodo • Electrode output range	5 – 150 A
Campo di regolazione TIG DC • TIG DC output range	5 – 150 A
Hot start • Hot start	Automatic
Arc force • Arc force	Automatic
Anti incollaggio • Antisticking	Automatic
Tipo innesco TIG DC • Type of arc ignition	LIFT ARC

ADV SERIES

INVERT 170/35 SL G-PROT

DDF115.170.T-E.01.00



CE

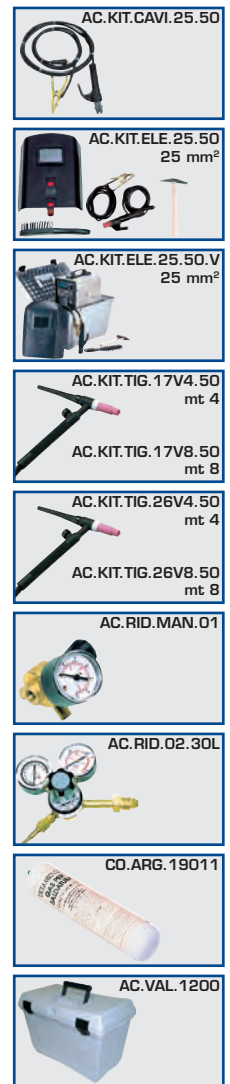

MMA TECH-CELL

PROCESSI / DUTY

Ciclo di lavoro TIG DC • TIG DC duty cycle	170 A – 45%
Corrente al 100 % • TIG DC output at 100% duty cycle	130 A
Ciclo di lavoro elettrodo • Electrode duty cycle	170 A – 35%
Corrente al 100 % • Electrode output at 100% duty cycle	115 A

INVERTER

Tensione di alimentazione • Mains voltage	230V ±10%
Frequenza • Frequency	50/60Hz
Tensione a vuoto • OCV	95 V
Potenza nominale elettrodo 100% • Electrode Nominal Power 100%	3,6 KW
Potenza nominale TIG DC 100% • TIG DC Nominal Power 100%	2,5 KW
Tensione d'arco elettrodo • Electrode arc voltage	20,2 – 26,8 V
Tensione d'arco TIG • TIG arc voltage	10,2 – 16,8 V
Corrente max • Max current	29 A
Fusibile di protezione • Protective Fuses	time lag 16 A ritardato
Fattore di potenza • Power factor	0,85
Grado di protezione • Degree of protection	IP 23 S
Classe d'isolamento • Insulation Class	F
Temperatura ambiente • Working temperature	-10°C+40°C
Dimensioni (mm) • Size (mm)	285x155x220
Peso (Kg) • Weight (Kg)	6,05

FUNZIONI / FEATURES

Campo di regolazione elettrodo • Electrode output range	5 – 170 A
Campo di regolazione TIG DC • TIG DC output range	5 – 170 A
Hot start • Hot start	Automatic
Arc force • Arc force	Automatic
Anti incollaggio • Antisticking	Automatic
Tipo innesco TIG DC • Type of arc ignition	LIFT ARC

INDUSTRIE SERIES

E 161 DCi

DDF115.160.T-E.01.00

E 161 CDi

DDD115.160.T-E.01.00



CE

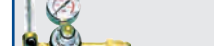
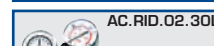
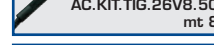
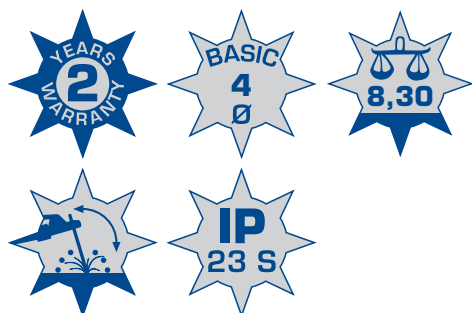

PROCESSI / DUTY

Ciclo di lavoro TIG DC • TIG DC duty cycle	160 A – 70%
Corrente al 100 % • TIG DC output at 100% duty cycle	135 A
Ciclo di lavoro elettrodo • Electrode duty cycle	160 A – 60%
Corrente al 100 % • Electrode output at 100% duty cycle	125 A

INVERTER

Tensione di alimentazione • Mains voltage	230V ±10%
Frequenza • Frequency	50/60Hz
Tensione a vuoto • OCV	75/85 V
Potenza nominale elettrodo 100% • Electrode Nominal Power 100%	3,9 KW
Potenza nominale TIG DC 100% • TIG DC Nominal Power 100%	2,6 KW
Tensione d'arco elettrodo • Electrode arc voltage	20,2 – 26,4 V
Tensione d'arco TIG • TIG arc voltage	10,2 – 16,4 V
Corrente max • Max current	27 A
Fusibile di protezione • Protective Fuses	time lag 16 A ritardato
Fattore di potenza • Power factor	0,85
Grado di protezione • Degree of protection	IP 23 S
Classe d'isolamento • Insulation Class	F
Temperatura ambiente • Working temperature	-10°C+40°C
Dimensioni (mm) • Size (mm)	285x180x220
Peso (Kg) • Weight (Kg)	8,30

FUNZIONI / FEATURES

Campo di regolazione elettrodo • Electrode output range	5 – 160 A
Campo di regolazione TIG DC • TIG DC output range	5 – 160 A
Hot start • Hot start	Automatic
Arc force • Arc force	selezionabile/on-off option
Anti incollaggio • Antisticking	Automatic
Tipo innesco TIG DC • Type of arc ignition	LIFT ARC
*Pulser • Pulser	SI/YES
*Frequenza pulser • Pulser frequency	3 OR 175 Hz
*Ciclo attivo pulser • Pulser duty cycle	50%

*Solo per il modello CDi • Only for CDi model

INDUSTRIE SERIES

C 181 CDi LONG ARC

DDD115.180.T-E.02.00

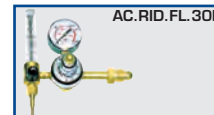
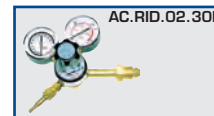

CE



PROCESSI / DUTY

Ciclo di lavoro TIG DC • TIG DC duty cycle	180 A – 50%
Corrente al 100 % • TIG DC output at 100% duty cycle	135 A
Ciclo di lavoro elettrodo • Electrode duty cycle	180 A – 40%
Corrente al 100 % • Electrode output at 100% duty cycle	125 A

INVERTER

Tensione di alimentazione • Mains voltage	230V ±10%
Frequenza • Frequency	50/60Hz
Tensione a vuoto • OCV	85 V
Potenza nominale elettrodo 100% • Electrode Nominal Power 100%	3,9 KW
Potenza nominale TIG DC 100% • TIG DC Nominal Power 100%	2,6 KW
Tensione d'arco elettrodo • Electrode arc voltage	20,2 – 27,2 V
Tensione d'arco TIG • TIG arc voltage	10,2 – 17,2 V
Corrente max • Max current	31 A
Fusibile di protezione • Protective Fuses	time lag 20 A ritardato
Fattore di potenza • Power factor	0,85
Grado di protezione • Degree of protection	IP 23 S
Classe d'isolamento • Insulation Class	F
Temperatura ambiente • Working temperature	-10°C+40°C
Dimensioni (mm) • Size (mm)	285x180x220
Peso (Kg) • Weight (Kg)	8,30

FUNZIONI / FEATURES

Campo di regolazione elettrodo • Electrode output range	5 – 180 A
Campo di regolazione TIG DC • TIG DC output range	5 – 180 A
Hot start • Hot start	Automatic
Arc force • Arc force	selezionabile/on-off option
Anti incollaggio • Antisticking	Automatic
Tipo innesco TIG DC • Type of arc ignition	LIFT ARC
Pulser • Pulser	SI/YES
Frequenza pulser • Pulser frequency	3 OR 175 Hz
Ciclo attivo pulser • Pulser duty cycle	50%

INDUSTRIE SERIES

C 201 CDi LONG ARC

DDD115.200.T-E.02.01

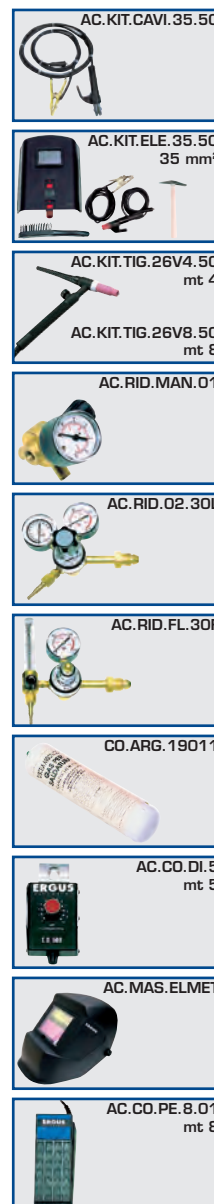

CE

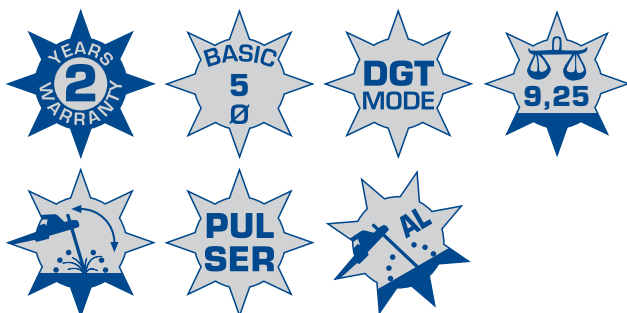

PROCESSI / DUTY

Ciclo di lavoro TIG DC • TIG DC duty cycle	200 A – 40%
Corrente al 100 % • TIG DC output at 100% duty cycle	140 A
Ciclo di lavoro elettrodo • Electrode duty cycle	200 A – 35%
Corrente al 100 % • Electrode output at 100% duty cycle	130 A

INVERTER

Tensione di alimentazione • Mains voltage	230V ±10%
Frequenza • Frequency	50/60Hz
Tensione a vuoto • OCV	85 V
Potenza nominale elettrodo 100% • Electrode Nominal Power 100%	4,1 KW
Potenza nominale TIG DC 100% • TIG DC Nominal Power 100%	2,7 KW
Tensione d'arco elettrodo • Electrode arc voltage	20,2 – 28,0 V
Tensione d'arco TIG • TIG arc voltage	10,2 – 18,0 V
Corrente max • Max current	36 A
Fusibile di protezione • Protective Fuses	time lag 20 A ritardato
Fattore di potenza • Power factor	0,85
Grado di protezione • Degree of protection	IP 21 S
Classe d'isolamento • Insulation Class	F
Temperatura ambiente • Working temperature	-10°C+40°C
Dimensioni (mm) • Size (mm)	385x180x220
Peso (Kg) • Weight (Kg)	9,25

FUNZIONI / FEATURES

Campo di regolazione elettrodo • Electrode output range	5 – 200 A
Campo di regolazione TIG DC • TIG DC output range	5 – 200 A
Hot start • Hot start	Automatic
Arc force • Arc force	selezionabile/on-off option
Anti incollaggio • Antisticking	Automatic
Tipo innesco TIG DC • Type of arc ignition	LIFT ARC
Pulsar • Pulsar	SI/YES
Frequenza pulsar • Pulsar frequency	3 OR 175 Hz
Ciclo attivo pulsar • Pulsar duty cycle	50%

INDUSTRIE SERIES



TECH-CELL 200 CDi G-PROT



PFD115.200.T-E.01.00



CE

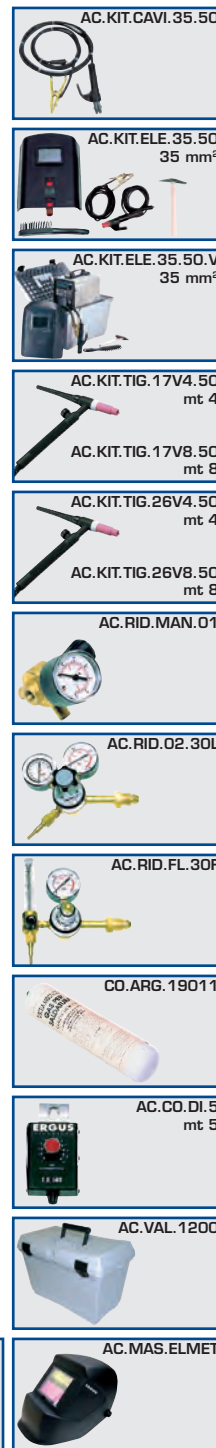
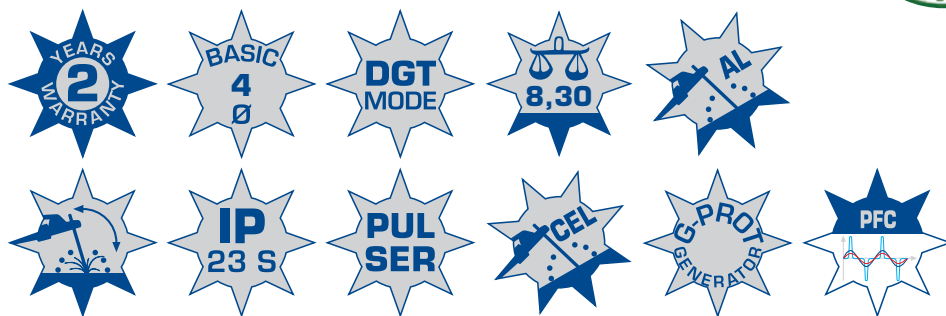

MMA TECH-CELL

PROCESSI / DUTY

Ciclo di lavoro TIG DC • TIG DC duty cycle	200 A – 35%
Corrente al 100 % • TIG DC output at 100% duty cycle	135 A
Ciclo di lavoro elettrodo • Electrode duty cycle	170 A – 40%
Corrente al 100 % • Electrode output at 100% duty cycle	125 A

INVERTER

Tensione di alimentazione • Mains voltage	90 – 270V
Frequenza • Frequency	50/60Hz
Tensione a vuoto • OCV	100 V
Potenza nominale elettrodo 100% • Electrode Nominal Power 100%	3,6 KW
Potenza nominale TIG DC 100% • TIG DC Nominal Power 100%	2,4 KW
Tensione d'arco elettrodo • Electrode arc voltage	20,2 – 26,8 V
Tensione d'arco TIG • TIG arc voltage	10,2 – 18 V
Corrente max • Max current	23 A
Fusibile di protezione • Protective Fuses	time lag 16 A ritardato
Fattore di potenza • Power factor	0,99
Grado di protezione • Degree of protection	IP 23 S
Classe d'isolamento • Insulation Class	F
Temperatura ambiente • Working temperature	-10°C+40°C
Dimensioni (mm) • Size (mm)	285x180x220
Peso (Kg) • Weight (Kg)	8,30

FUNZIONI / FEATURES

Campo di regolazione elettrodo • Electrode output range	5 – 170 A
Campo di regolazione TIG DC • TIG DC output range	5 – 200 A
Hot start • Hot start	Automatic
Arc force • Arc force	Automatic
Anti incollaggio • Antisticking	Automatic
Funzione cellulosico • Cellulosic function	selezionabile/on-off option
Tipo innesco TIG DC • Type of arc ignition	LIFT ARC
Pulser • Pulser	SI/YES
Frequenza pulser • Pulser frequency	3 OR 175 Hz
Ciclo attivo pulser • Pulser duty cycle	50%

*Tutti i dati tecnici sono riferiti ad una tensione di alimentazione di 230Vac
All the technical data here reported relate to input voltage 230Vac

INDUSTRIE SERIES

E 250 DCi

DDF115.250.T-E.01.00



E 250 CDi

DDD115.250.T-E.01.00

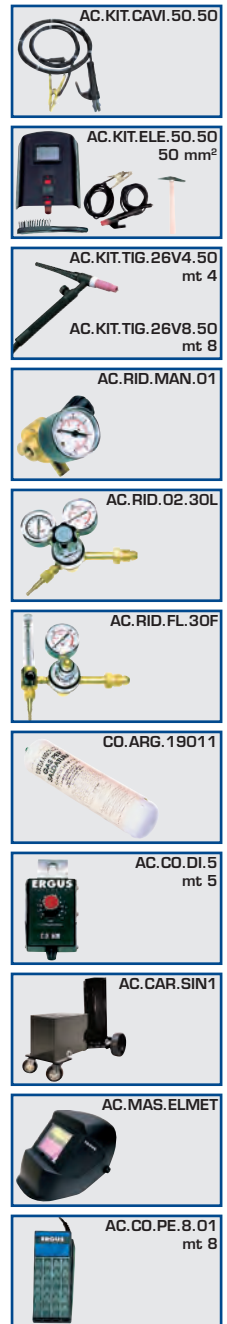

CE



PROCESSI / DUTY

Ciclo di lavoro TIG DC • TIG DC duty cycle	250 A – 70%
Corrente al 100 % • TIG DC output at 100% duty cycle	210 A
Ciclo di lavoro elettrodo • Electrode duty cycle	250 A – 60%
Corrente al 100 % • Electrode output at 100% duty cycle	195 A

INVERTER

Tensione di alimentazione • Mains voltage	3x400V-10+15%
Frequenza • Frequency	50/60Hz
Tensione a vuoto • OCV	75 V/105 V
Potenza nominale elettrodo 100% • Electrode Nominal Power 100%	6,8 KW
Potenza nominale TIG DC 100% • TIG DC Nominal Power 100%	4,8 KW
Tensione d'arco elettrodo • Electrode arc voltage	20,2 – 30,0 V
Tensione d'arco TIG • TIG arc voltage	10,2 – 20,0 V
Corrente max • Max current	16 A
Fusibile di protezione • Protective Fuses	time lag 16 A ritardato
Fattore di potenza • Power factor	0,85
Grado di protezione • Degree of protection	IP 23 S
Classe d'isolamento • Insulation Class	F
Temperatura ambiente • Working temperature	-10°C+40°C
Dimensioni (mm) • Size (mm)	400x180x225
Peso (Kg) • Weight (Kg)	13,00

FUNZIONI / FEATURES

Campo di regolazione elettrodo • Electrode output range	5 – 250 A
Campo di regolazione TIG DC • TIG DC output range	5 – 250 A
Hot start • Hot start	Automatic
Arc force • Arc force	selezionabile/on-off option
Anti incollaggio • Antisticking	Automatic
Tipo innesco TIG DC • Type of arc ignition	LIFT ARC
*Pulser • Pulser	SI/YES
*Frequenza pulser • Pulser frequency	3 OR 175 Hz
*Ciclo attivo pulser • Pulser duty cycle	50%

*Solo per il modello CDi • Only for CDi model

INDUSTRIE SERIES **TECH CELL**

TECH-CELL 250 CDi

DDD115.250.T-E.05.00



CE



PROCESSI / DUTY

Ciclo di lavoro TIG DC • TIG DC duty cycle	250 A – 60%
Corrente al 100 % • TIG DC output at 100% duty cycle	195 A
Ciclo di lavoro elettrodo • Electrode duty cycle	250 A – 50%
Corrente al 100 % • Electrode output at 100% duty cycle	175 A

INVERTER

Tensione di alimentazione • Mains voltage	3x400V-10+15%
Frequenza • Frequency	50/60Hz
Tensione a vuoto • OCV	105 V
Potenza nominale elettrodo 100% • Electrode Nominal Power 100%	5,9 KW
Potenza nominale TIG DC 100% • TIG DC Nominal Power 100%	4,3 KW
Tensione d'arco elettrodo • Electrode arc voltage	20,2 – 30,0 V
Tensione d'arco TIG • TIG arc voltage	10,2 – 20,0 V
Corrente max • Max current	16 A
Fusibile di protezione • Protective Fuses	time lag 16 A ritardato
Fattore di potenza • Power factor	0,85
Grado di protezione • Degree of protection	IP 23 S
Classe d'isolamento • Insulation Class	F
Temperatura ambiente • Working temperature	-10°C+40°C
Dimensioni (mm) • Size (mm)	400x180x225
Peso (Kg) • Weight (Kg)	13,00

FUNZIONI / FEATURES

Campo di regolazione elettrodo • Electrode output range	5 – 250 A
Campo di regolazione TIG DC • TIG DC output range	5 – 250 A
Hot start • Hot start	Automatic
Arc force • Arc force	Automatic
Anti incollaggio • Antisticking	Automatic
Funzione cellulosico • Cellulosic function	selezionabile/on-off option
Tipo innesco TIG DC • Type of arc ignition	LIFT ARC
Pulser • Pulser	SI/YES
Frequenza pulser • Pulser frequency	3 OR 175 Hz
Ciclo attivo pulser • Pulser duty cycle	50%

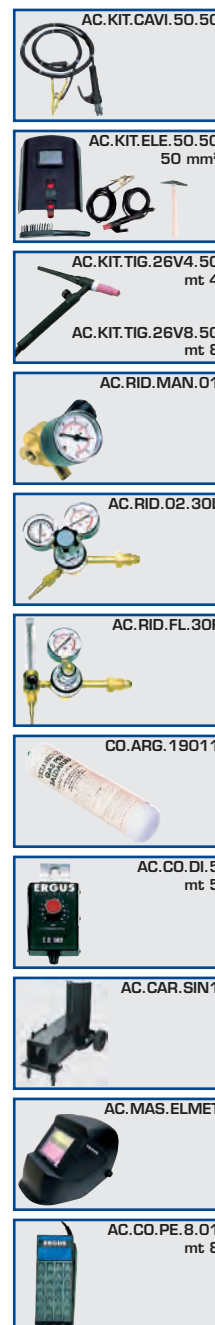

MMA TECH-CELL

INDUSTRIE SERIES

E 320 DCi

DDF115.320.T-E.03.00



E 320 CDi

DDD115.320.T-E.01.00

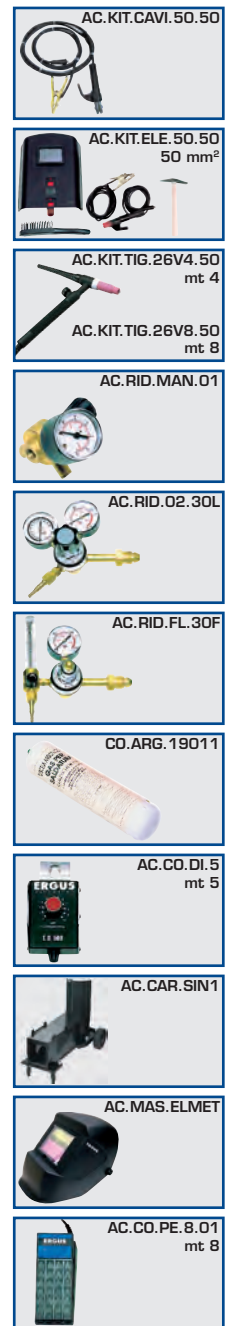

CE

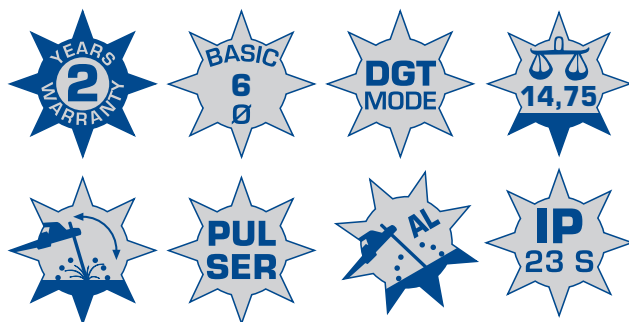

PROCESSI / DUTY

Ciclo di lavoro TIG DC • TIG DC duty cycle	320 A – 70%
Corrente al 100 % • TIG DC output at 100% duty cycle	265 A
Ciclo di lavoro elettrodo • Electrode duty cycle	320 A – 60%
Corrente al 100 % • Electrode output at 100% duty cycle	245 A

INVERTER

Tensione di alimentazione • Mains voltage	3x400-10+15%
Frequenza • Frequency	50/60Hz
Tensione a vuoto • OCV	75 V/105 V
Potenza nominale elettrodo 100% • Electrode Nominal Power 100%	9,1 KW
Potenza nominale TIG DC 100% • TIG DC Nominal Power 100%	6,8 KW
Tensione d'arco elettrodo • Electrode arc voltage	20,2 – 32,8 V
Tensione d'arco TIG • TIG arc voltage	10,2 – 22,8 V
Corrente max • Max current	22,5 A
Fusibile di protezione • Protective Fuses	time lag 20 A ritardato
Fattore di potenza • Power factor	0,85
Grado di protezione • Degree of protection	IP 23 S
Classe d'isolamento • Insulation Class	F
Temperatura ambiente • Working temperature	-10°C+40°C
Dimensioni (mm) • Size (mm)	420x180x265
Peso (Kg) • Weight (Kg)	14,75

FUNZIONI / FEATURES

Campo di regolazione elettrodo • Electrode output range	5 – 320 A
Campo di regolazione TIG DC • TIG DC output range	5 – 320 A
Hot start • Hot start	Automatic
Arc force • Arc force	selezionabile/on-off option
Anti incollaggio • Antisticking	Automatic
Tipo innesco TIG DC • Type of arc ignition	LIFT ARC
*Pulser • Pulser	SI/YES
*Frequenza pulser • Pulser frequency	3 OR 175 Hz
*Ciclo attivo pulser • Pulser duty cycle	50%

*Solo per il modello CDi • Only for CDi model

Accessori / Accessories MMA



AC.CM.16.25.2 massa/cable earth 16 mm² mt. 2 TX 25
 AC.CM.25.50.4 massa/cable earth 25 mm² mt. 4 TX 50
 AC.CM.35.50.4 massa/cable earth 35 mm² mt. 4 TX 50
 AC.CM.50.50.4 massa/cable earth 50 mm² mt. 4 TX 50



AC.RID.FL.30F riduttore con fluss. 801DB-30FAR-719
 flowmeter gas pressure



AC.KIT.CAVI.16.25 kit cavi elettrodo 3+2 16 mm² TX25
 AC.KIT.CAVI.25.50 kit cavi elettrodo 3+2 25 mm² TX50
 AC.KIT.CAVI.35.50 kit cavi elettrodo 3+2 35 mm² TX50
 AC.KIT.CAVI.50.50 kit cavi elettrodo 3+2 50 mm² TX50
 welding wires



CO.ARG.19011 bombola ARGON
 ARGON cylinder



AC.KIT.ELE.16.25 kit electrode set 3+2 mt. da 16 TX 25
 AC.KIT.ELE.25.50 kit electrode set 3+2 mt. da 25 TX 50
 AC.KIT.ELE.35.50 kit electrode set 3+2 mt. da 35 TX 50
 AC.KIT.ELE.50.50 kit electrode set 3+2 mt. da 50 TX 50



AC.CO.DI.5 comando a distanza CD 500 mt. 5
 remote control box



AC.KIT.ELE.16.25.V suitcase kit 3+2 mt. da 16 TX 25
 AC.KIT.ELE.25.50.V suitcase kit 3+2 mt. da 25 TX 50
 AC.KIT.ELE.35.50.V suitcase kit 3+2 mt. da 35 TX 50



AC.CO.PU.5 comando pulser CP 500 mt. 5
 pulser control box



MMCD00600 spina mobile 60059 NG
 male connector TX 50



AC.GBOX G-BOX



MMCD00500 spina mobile 60029 NG
 male connector TX 25



AC.CAR.SIN1 carrello con blocco saldatrici
 trolley



MMCH00570 connettore comando a distanza
 connector 7 pin
 (remote control)



AC.VAL.1200 valigetta / suitcase RAL 7040



AC.RID.02.30L riduttore a 2 manometri 801B-30L-AR
 gas pressure gauge



AC.MAS.ELMET maschera ad elmetto autoscurante
 self darkening helmet



AC.RID.MAN.01 riduttore a 1 manometro per bombole usa
 e getta.
 gas pressure gauge for disposable gas
 cylinder.



AC.CO.PE.8.01 comando a pedale CF 400 mt. 8
 foot control mt. 8



AC.KIT.TIG.17V4.25 torch 17V4 C/manual mt. 4 TX 25
 140A DC/125A AC @ 35%
 AC.KIT.TIG.17V8.25 torch 17V8 C/manual mt. 8 TX 25
 140A DC/125A AC @ 35%
 AC.KIT.TIG.17V4.50 torch 17V4 C/manual mt. 4 TX 50
 140A DC/125A AC @ 35%
 AC.KIT.TIG.17V8.50 torch 17V8 C/manual mt. 8 TX 50
 140A DC/125A AC @ 35%
 AC.KIT.TIG.26V4.50 torch 26V4 C/manual mt. 4 TX 50
 180A DC/150A AC @ 35%
 AC.KIT.TIG.26V8.50 torch 26V8 C/manual mt. 8 TX 50
 180A DC/150A AC @ 35%

LA SALDATURA TIG

La saldatura TIG (Tungsten Inert Gas) avviene grazie all'arco che si crea tra un elettrodo infusibile (Tungsteno) e il pezzo da saldare. L'elettrodo, la zona fusa e l'arco elettrico sono protetti da un gas inerte (ARGON). La saldatura può avvenire con o senza materiale di apporto; quando si apporta del materiale la bacchetta di apporto deve essere compatibile con il pezzo da saldare (Fe - inox - Alluminio, ecc...).

VANTAGGI

procedimento molto pulito e senza scoria. Il cordone risulta con un'ottima penetrazione, ha un bell'aspetto e non richiede le consuete operazioni di finitura.

- con il metodo TIG si può saldare la maggioranza dei materiali:
- FE - INOX - RAME in corrente continua (DC)
- ALLUMINIO e sue leghe in corrente alternata (AC).

Con il nuovo sistema di controllo a microprocessore sui modelli CDi è possibile utilizzare una corrente continua pulsata che permette un miglior controllo del bagno in particolari condizioni operative.

Nella figura viene mostrato il principio: Il bagno di saldature viene formato dagli impulsi di picco (I_p), mentre la corrente di base (I_b) mantiene l'arco acceso.

Questa soluzione facilita la saldatura di piccoli spessori e, confrontata ad una saldatura a TIG tradizionale, eseguita a pari valori di corrente media (I_m), assicura una zona termicamente limitata senza perforazioni, con minori deformazioni, minor pericolo di cricche a caldo e di inclusioni gassose.

ATTENZIONE!

Nella saldatura TIG DC e AC l'elettrodo di Tungsteno non deve mai venire a contatto con il pezzo da saldare. Per questo motivo si deve innescare l'arco a distanza tramite impulsi di alta frequenza (HF) o, in alternativa, con il metodo LIFT che mantiene una buona qualità di innescamento ma ne rallenta l'operazione in quanto per innescare l'arco, l'elettrodo deve toccare il pezzo. Esistono tre tipologie di elettrodo in tungsteno contraddistinte dai colori:

ELETTRODO

Tungsteno Ceriato
Tungsteno Puro

COLORE

Grigio
Verde/Bleu

IMPIEGO

Universale
Alluminio e le sue leghe

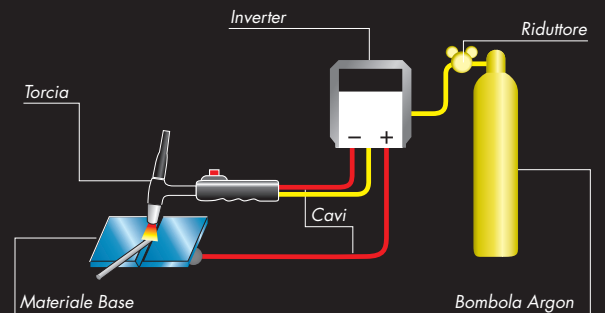
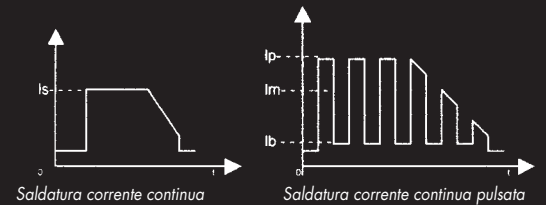
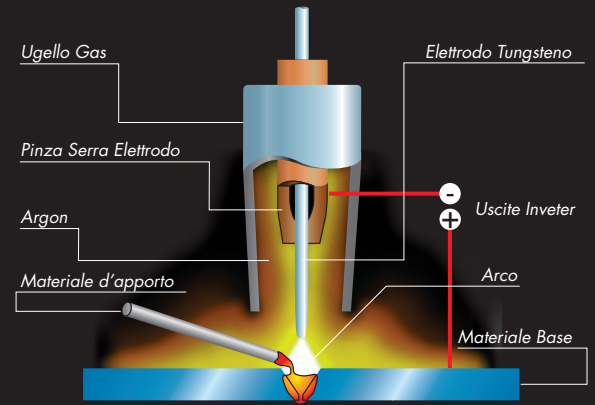

TIG WELDING

In TIG (Tungsten Inert Gas) welding, an arc between the work-piece and the non-melting electrode (Tungsten/Wolfram) is created. Work-piece, electrode and arc are protected from atmospheric oxidation by the shielding gas (Argon) coming out from the TIG torch. TIG welding can be done with or without filling material. When filling material sticks are used, they must be perfectly compatible with the work-piece (steel, stainless steel, aluminium, etc.).

ADVANTAGES

TIG welding is clean and without slag. The arc has excellent penetration and the seam is regular. There is no need to clean, brush or grind the seam.

TIG welding is used for many metals:

- Steel, Stainless Steel, Copper, in DC welding;
- Aluminium and light alloys in AC welding.

Our Cdi models have a new microprocessor welding control. Those models have an important pulsed current feature that allow for a better welding optimisation and seam control.

The figure above shows how pulse current operates:

The base current (I_b) maintains the arc, while the seam is created by the spike pulsing (I_p).

This feature makes thin work-piece welding easier, avoids holes creation, decreases the size of the HAZ (Heat Affected Zone) thus having minor heat dispersion, minor material deforming, no heat cracks and no bubble inclusion.

WARNING!

When welding TIG DC or AC mode, HF ignition system inverters should be operated to avoid contact between the electrode (Tungsten) and the work-piece. Another solution for inexpensive TIG inverters is LIFT ignition where the Tungsten electrode must lightly touch the work-piece in order to get arc ignition, which is slowing down the operation.

There are three different types of Tungsten electrodes, of two different colours:

ELECTRODE

Cerium Tungsten
Pure Tungsten

COLOUR

Grey
Green/Blue

USE

Universal
Aluminium and light alloys

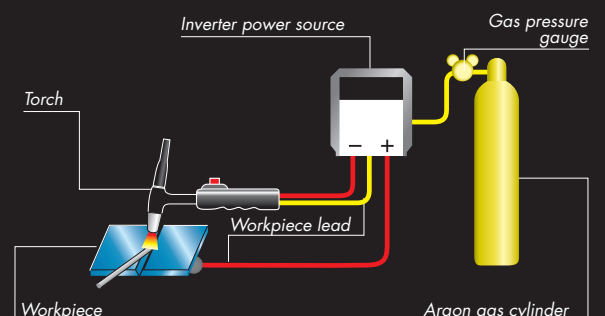
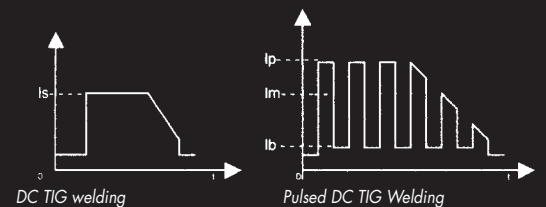
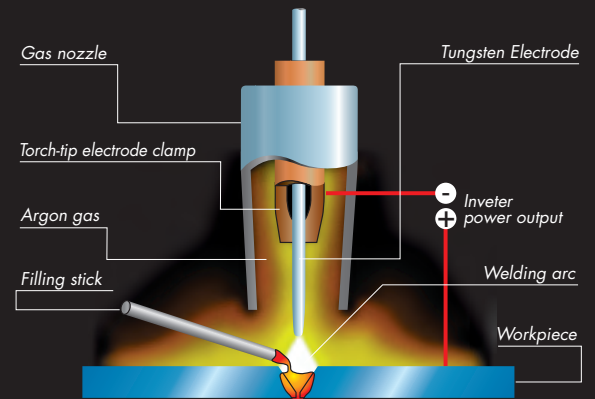

ADV SERIES

DIGITIG 170/50 HF G-PROT

DDD115.170.T-E.02.00

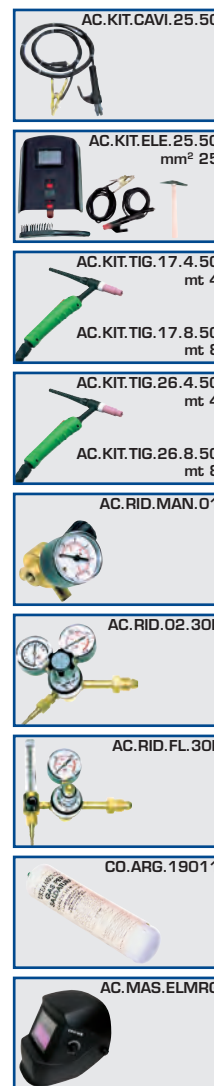

TIG DC

CE



PROCESSI / DUTY

Ciclo di lavoro TIG DC • TIG DC duty cycle	170 A – 60%
Corrente al 100 % • TIG DC output at 100% duty cycle	120 A
Ciclo di lavoro elettrodo • Electrode duty cycle	170 A – 50%
Corrente al 100 % • Electrode output at 100% duty cycle	105 A

INVERTER

Tensione di alimentazione • Mains voltage	230V±10%
Frequenza • Frequency	50/60Hz
Tensione a vuoto • OCV	100 V
Potenza nominale elettrodo 100% • Electrode Nominal Power 100%	3,5 KW
Potenza nominale TIG DC 100% • TIG DC Nominal Power 100%	2,3 KW
Tensione d'arco elettrodo • Electrode arc voltage	20,2 – 26,8 V
Tensione d'arco TIG • TIG arc voltage	10,2 – 16,8 V
Corrente max • Max current	29 A
Fusibile di protezione • Protective Fuses	time lag 20 A ritardato
Fattore di potenza • Power factor	0,85
Grado di protezione • Degree of protection	IP 23 S
Classe d'isolamento • Insulation Class	F
Temperatura ambiente • Working temperature	-10°C+40°C
Dimensioni (mm) • Size (mm)	405x155x220
Peso (Kg) • Weight (Kg)	8,80

FUNZIONI / FEATURES

Campo di regolazione elettrodo • Electrode output range	5 – 170 A
Campo di regolazione TIG DC • TIG DC output range	5 – 170 A
Hot start • Hot start	Automatic
Arc force • Arc force	selezionabile/on/off option
Anti incollaggio • Antisticking	Automatic
Tipo innesco TIG DC • Type of arc ignition	HF/LIFT ARC
Comando consenso TIG • TIG DC control	2/4T - STEP
Corrente di base • Base current	5-100%
Regolazione tempo di salita • Slope up	0-20sec
Regolazione tempo di discesa • Slope down	0-20sec
Regolazione ritardo gas • Post gas	0,5-20sec
Corrente finale • End current	5-100%
Pulser • Pulser	SI / YES
Frequenza pulser • Pulser frequency	1-300 Hz
Memorie • Program Memories	3

INDUSTRIE SERIES

WIG 171 HF ADi

DDA115.170.T-E.01.01



WIG 170 HF CDi

DDD115.170.T-E.01.00



CE

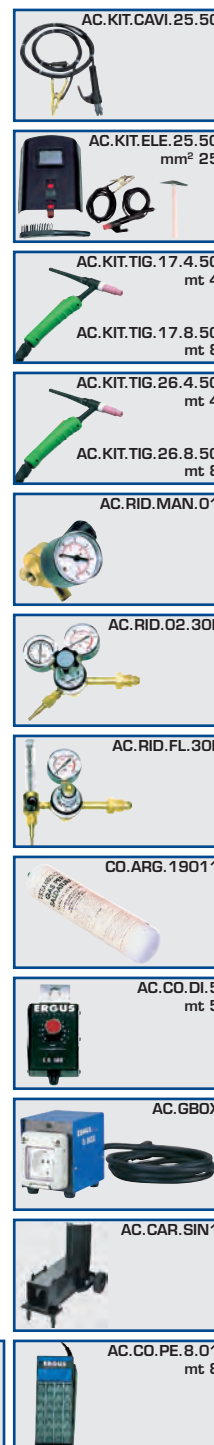

PROCESSI / DUTY	
Ciclo di lavoro TIG DC • TIG DC duty cycle	170 A – 60%
Corrente al 100 % • TIG DC output at 100% duty cycle	130 A
Ciclo di lavoro elettrodo • Electrode duty cycle	170 A – 50%
Corrente al 100 % • Electrode output at 100% duty cycle	120 A

INVERTER	
Tensione di alimentazione • Mains voltage	230V±10%
Frequenza • Frequency	50/60Hz
Tensione a vuoto • OCV	85 V
Potenza nominale elettrodo 100% • Electrode Nominal Power 100%	3,7 KW
Potenza nominale TIG DC 100% • TIG DC Nominal Power 100%	2,5 KW
Tensione d'arco elettrodo • Electrode arc voltage	20,2 – 26,8 V
Tensione d'arco TIG • TIG arc voltage	10,2 – 16,8 V
Corrente max • Max current	29 A
Fusibile di protezione • Protective Fuses	time lag 16 A ritardato
Fattore di potenza • Power factor	0,85
Grado di protezione • Degree of protection	IP 23 S
Classe d'isolamento • Insulation Class	F
Temperatura ambiente • Working temperature	-10°C+40°C
Dimensioni (mm) • Size (mm)	385x180x220
Peso (Kg) • Weight (Kg)	10,25

*Solo per il modello CDi • Only for CDi model

FUNZIONI / FEATURES	
Campo di regolazione elettrodo • Electrode output range	5 – 170 A
Campo di regolazione TIG DC • TIG DC output range	5 – 170 A
Hot start • Hot start	Automatic
Arc force • Arc force	selezionabile/on/off option
Anti incollaggio • Antisticking	Automatic
Tipo innesco TIG DC • Type of arc ignition	HF/LIFT ARC
Comando consenso TIG • TIG DC control	2/4 T - STEP
Corrente di base • Base current	min. ÷ 80%
Regolazione tempo di salita • Slope up	0-20sec
Regolazione tempo di discesa • Slope down	0-20sec
Regolazione ritardo gas • Post gas	0-20sec
Corrente finale • End current	min. ÷ 80%
Pulser • Pulser	SI / YES
Frequenza pulser • Pulser frequency	1-500 Hz / *1-400 Hz
*Ciclo attivo pulser • Pulser duty cycle	10 - 90%
*Memorie • Program Memories	18
*Bi-level	SI / YES

INDUSTRIE SERIES

WIG 201 HF ADi

DDA115.200.T-E.01.01

WIG 201 HF CDi

DDD115.200.T-E.01.02



CE



PROCESSI / DUTY	
Ciclo di lavoro TIG DC • TIG DC duty cycle	200 A – 40%
Corrente al 100 % • TIG DC output at 100% duty cycle	140 A
Ciclo di lavoro elettrodo • Electrode duty cycle	170 A – 50%
Corrente al 100 % • Electrode output at 100% duty cycle	130 A

INVERTER	
Tensione di alimentazione • Mains voltage	230V±10%
Frequenza • Frequency	50/60Hz
Tensione a vuoto • OCV	85 V
Potenza nominale elettrodo 100% • Electrode Nominal Power 100%	4,1 KW
Potenza nominale TIG DC 100% • TIG DC Nominal Power 100%	2,7 KW
Tensione d'arco elettrodo • Electrode arc voltage	20,2 – 26,8 V
Tensione d'arco TIG • TIG arc voltage	10,2 – 18,0 V
Corrente max • Max current	29 A
Fusibile di protezione • Protective Fuses	time lag 20 A ritardato
Fattore di potenza • Power factor	0,85
Grado di protezione • Degree of protection	IP 23 S
Classe d'isolamento • Insulation Class	F
Temperatura ambiente • Working temperature	-10°C+40°C
Dimensioni (mm) • Size (mm)	385x180x220
Peso (Kg) • Weight (Kg)	10,25

*Solo per il modello CDi • Only for CDi model

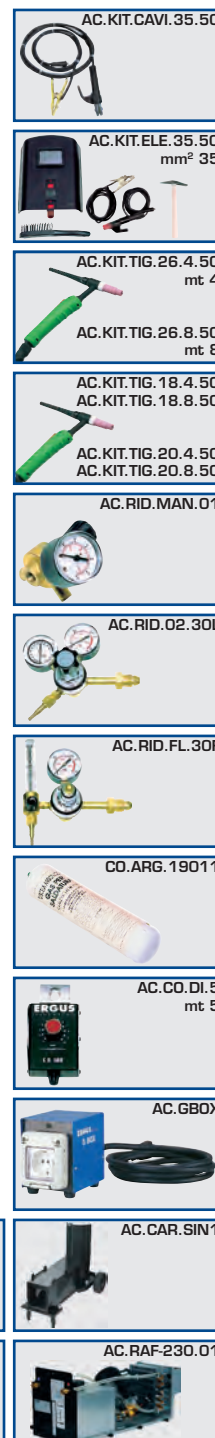

FUNZIONI / FEATURES	
Campo di regolazione elettrodo • Electrode output range	5 – 170 A
Campo di regolazione TIG DC • TIG DC output range	5 – 200 A
Hot start • Hot start	Automatic
Arc force • Arc force	selezionabile/on/off option
Anti incollaggio • Antisticking	Automatic
Tipo innesco TIG DC • Type of arc ignition	HF/LIFT ARC
Comando consenso TIG • TIG DC control	2/4 T - STEP
Corrente di base • Base current	min. ÷ 80%
Regolazione tempo di salita • Slope up	0-20sec
Regolazione tempo di discesa • Slope down	0-20sec
Regolazione ritardo gas • Post gas	0-20sec
Corrente finale • End current	min. ÷ 80%
Pulser • Pulser	SI / YES
Frequenza pulser • Pulser frequency	1-500 Hz / *1-400 Hz
*Ciclo attivo pulser • Pulser duty cycle	10 - 90%
*Memorie • Program Memories	18
*Bi-level	SI / YES

TIG DC

INDUSTRIE SERIES

WIG 251 HF ADi

DDA115.250.T-E.01.00

WIG 250 HF CDi

DDD115.250.T-E.02.02



CE

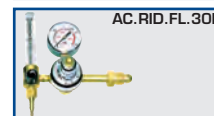
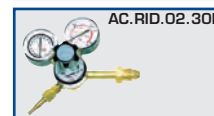
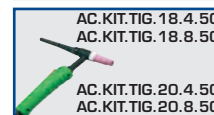

PROCESSI / DUTY	
Ciclo di lavoro TIG DC • TIG DC duty cycle	250 A – 70%
Corrente al 100 % • TIG DC output at 100% duty cycle	210 A
Ciclo di lavoro elettrodo • Electrode duty cycle	250 A – 60%
Corrente al 100 % • Electrode output at 100% duty cycle	195 A

INVERTER	
Tensione di alimentazione • Mains voltage	3x400V-10+15%
Frequenza • Frequency	50/60Hz
Tensione a vuoto • OCV	85 V
Potenza nominale elettrodo 100% • Electrode Nominal Power 100%	6,8 KW
Potenza nominale TIG DC 100% • TIG DC Nominal Power 100%	4,8 KW
Tensione d'arco elettrodo • Electrode arc voltage	20,2 – 30,0 V
Tensione d'arco TIG • TIG arc voltage	10,2 – 20,0 V
Corrente max • Max current	16 A
Fusibile di protezione • Protective Fuses	time lag 16 A ritardato
Fattore di potenza • Power factor	0,85
Grado di protezione • Degree of protection	IP 23 S
Classe d'isolamento • Insulation Class	F
Temperatura ambiente • Working temperature	-10°C+40°C
Dimensioni (mm) • Size (mm)	400x180x225
Peso (Kg) • Weight (Kg)	15,50

*Solo per il modello CDi • Only for CDi model

FUNZIONI / FEATURES	
Campo di regolazione elettrodo • Electrode output range	5 – 250 A
Campo di regolazione TIG DC • TIG DC output range	5 – 250 A
Hot start • Hot start	Automatic
Arc force • Arc force	selezionabile/on/off option
Anti incollaggio • Antisticking	Automatic
Tipo innesco TIG DC • Type of arc ignition	HF/LIFT ARC
Comando consenso TIG • TIG DC control	2/4 T - STEP
Corrente di base • Base current	min. ÷ 80%
Regolazione tempo di salita • Slope up	0-20sec
Regolazione tempo di discesa • Slope down	0-20sec
Regolazione ritardo gas • Post gas	0-20sec
Corrente finale • End current	min. ÷ 80%
Pulser • Pulser	SI / YES
Frequenza pulser • Pulser frequency	1-500 Hz / *1-400 Hz
*Ciclo attivo pulser • Pulser duty cycle	10 - 90%
*Memorie • Program Memories	18
*Bi-level	SI / YES

INDUSTRIE SERIES

WIG 321 HF ADi

DDA115.320.T-E.01.01

WIG 320 HF CDi

DDD115.320.T-E.02.01



CE

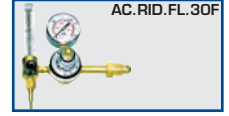
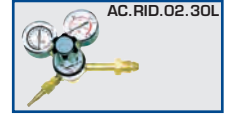

TIG DC

PROCESSI / DUTY

Ciclo di lavoro TIG DC • TIG DC duty cycle	320 A – 70%
Corrente al 100 % • TIG DC output at 100% duty cycle	265 A
Ciclo di lavoro elettrodo • Electrode duty cycle	320 A – 60%
Corrente al 100 % • Electrode output at 100% duty cycle	245 A

INVERTER

Tensione di alimentazione • Mains voltage	3x400V-10+15%
Frequenza • Frequency	50/60Hz
Tensione a vuoto • OCV	85 V
Potenza nominale elettrodo 100% • Electrode Nominal Power 100%	9,1 KW
Potenza nominale TIG DC 100% • TIG DC Nominal Power 100%	6,8 KW
Tensione d'arco elettrodo • Electrode arc voltage	20,2 – 32,8 V
Tensione d'arco TIG • TIG arc voltage	10,2 – 22,8 V
Corrente max • Max current	22,5 A
Fusibile di protezione • Protective Fuses	time lag 20 A ritardato
Fattore di potenza • Power factor	0,85
Grado di protezione • Degree of protection	IP 23 S
Classe d'isolamento • Insulation Class	F
Temperatura ambiente • Working temperature	-10°C+40°C
Dimensioni (mm) • Size (mm)	420x180x265
Peso (Kg) • Weight (Kg)	16,80

FUNZIONI / FEATURES

Campo di regolazione elettrodo • Electrode output range	5 – 320 A
Campo di regolazione TIG DC • TIG DC output range	5 – 320 A
Hot start • Hot start	Automatic
Arc force • Arc force	selezionabile/on - off option
Anti incollaggio • Antisticking	Automatic
Tipo innesco TIG DC • Type of arc ignition	HF/LIFT ARC
Comando consenso TIG • TIG DC control	2/4 T - STEP
Corrente di base • Base current	min. ÷ 80%
Regolazione tempo di salita • Slope up	0-20sec
Regolazione tempo di discesa • Slope down	0-20sec
Regolazione ritardo gas • Post gas	0-20sec
Corrente finale • End current	min. ÷ 80%
Pulser • Pulser	SI / YES
Frequenza pulser • Pulser frequency	1-500 Hz / *1-400 Hz
*Ciclo attivo pulser • Pulser duty cycle	10 - 90%
*Memorie • Program Memories	18
*Bi-level	SI / YES

*Solo per il modello CDi • Only for CDi model

CORRENTE ALTERNATA AC

La **CORRENTE CONTINUA** unidirezionale prodotta dai generatori tradizionali presenta oscillazioni; i generatori ad inverter garantiscono invece una corrente costante e meglio raddrizzata, che rende l'arco molto più stabile, concentrato e silenzioso. Tutto questo grazie alle elevate frequenze di conversione impiegate (50-100 kHz).

Corrente Alternata ad Onda Quadra

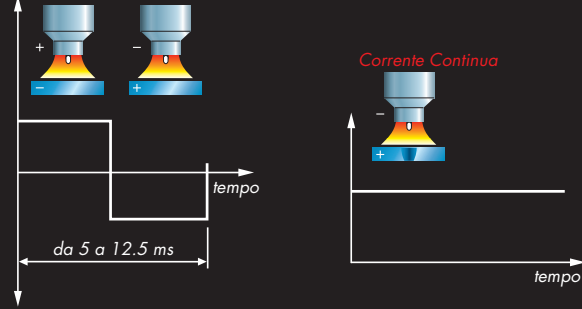

La **CORRENTE ALTERNATA** di rete (utilizzata dai generatori tradizionali) cambia di polarità passando dal polo positivo al polo negativo, a una frequenza di 50 Hz. La particolare tecnologia dei nuovi generatori, che erogano corrente alternata ad onda quadra ad una frequenza da 80 a 200 Hz, ha ridotto i tempi di passaggio dalla semionda positiva a quella negativa, garantendo quindi una perfetta concentrazione e stabilità dell'arco. Un altro vantaggio è la possibilità di aumentare o diminuire la percentuale della durata della semionda positiva o negativa mediante la regolazione della manopola del bilanciamento, che ne permette la modifica continua al fine di accrescere la penetrazione o la pulizia.

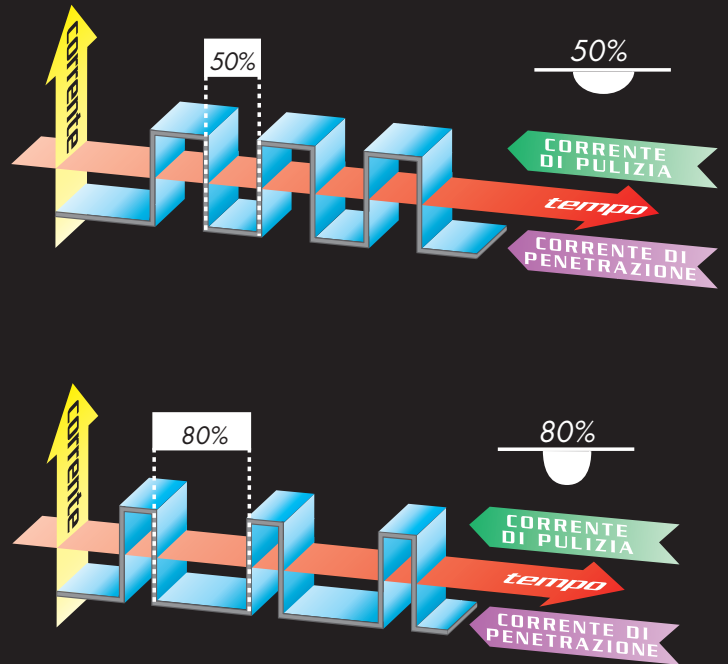

ATTENZIONE!

- Gli inverter a corrente alternata ad onda quadra si devono utilizzare per saldare l'alluminio e le sue leghe perché l'ossido presente sull'alluminio (allumina) ha un punto di fusione superiore a quello del metallo stesso.

AC WELDING

DC WELDING with traditional transformer rectifiers produces arc oscillations, leading to low quality welding. Inverters instead provide smooth and stable output, with subsequent enhanced arc quality. An inverter operates at much higher frequency (50-100 KHz).

Square wave AC

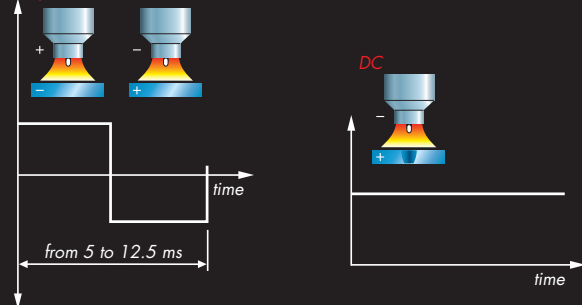

AC WELDING used by traditional power sources operates at 50/60 Hz with polarity oscillation being changed from plus to minus and back. The above mentioned working frequency is no guaranty of arc stability. Conversely, the AC inverter operates with an 80-200 Hz square wave, thus reducing the interval from plus to minus semi-wave and back, giving the arc more stability and concentration of power. This plus/minus cycle is manually adjustable and is used by the operator to increase or decrease arc penetration and to obtain a cleaner weld.

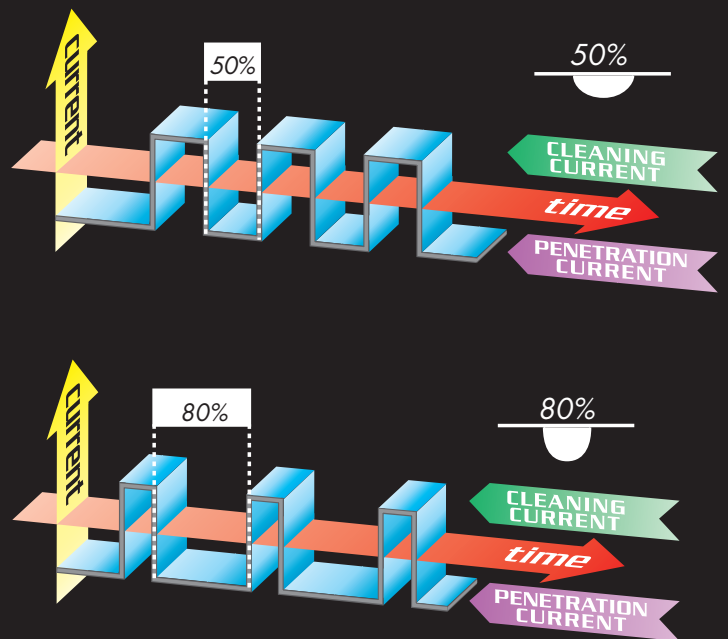

WARNING!

- AC square wave inverters must be used for TIG aluminium and light alloy welding, because the oxidised coating (alumina) has a higher melting point than the workpiece itself.

INDUSTRIE SERIES

WIG 200 HF AC/DC

DDF115.200.T-E.03.00

WIG 200 HF AC/DC CDi

DDD115.200.T-E.04.00



CE

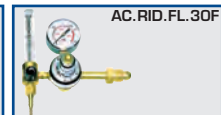
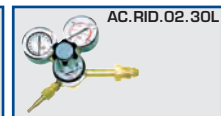

TIG AC/DC

PROCESSI / DUTY

Ciclo di lavoro TIG DC • TIG DC duty cycle	200 A – 40%
Corrente al 100 % • TIG DC output at 100% duty cycle	140 A
Ciclo di lavoro TIG AC • TIG AC duty cycle	200 A – 40%
Corrente al 100 % • TIG AC output at 100% duty cycle	140 A
Ciclo di lavoro elettrodo • Electrode duty cycle	160 A – 60%
Corrente al 100 % • Electrode output at 100% duty cycle	130 A

INVERTER

Tensione di alimentazione • Mains voltage	230V ±10%
Frequenza • Frequency	50/60Hz
Tensione a vuoto • OCV	95 V
Potenza nominale elettrodo 100% • Electrode Nominal Power 100%	4,1 KW
Potenza nominale TIG DC 100% • TIG DC Nominal Power 100%	2,8 KW
Potenza nominale TIG AC 100% • TIG AC Nominal Power 100%	2,8 KW
Tensione d'arco elettrodo • Electrode arc voltage	20,2 – 26,4 V
Tensione d'arco TIG • TIG arc voltage	10,2 – 18,0 V
Corrente max • Max current	27 A
Fusibile di protezione • Protective Fuses	time lag 20 A ritardato
Fattore di potenza • Power factor	0,85
Grado di protezione • Degree of protection	IP 23 S
Classe d'isolamento • Insulation Class	F
Temperatura ambiente • Working temperature	-10°C+40°C
Dimensioni (mm) • Size (mm)	430x235x375/425x230x415*
Peso (Kg) • Weight (Kg)	17,15

FUNZIONI / FEATURES

Regolazione elettrodo • Electrode output range	5 – 160 A
Hot start • Hot start	Regolabile /Adjustable
Arc force • Arc force	Automatic /0-100%*
Anti incollaggio • Antisticking	Automatic
Regolazione TIG • TIG output range	5 – 200 A
Comando consenso TIG • TIG control	2/4 T - STEP
*Pre gas • Pre gas	0-30sec
Post gas • Post gas	0-20sec /0-30sec*
Corrente di base • Base current	Regolabile /Adjustable min. ÷ 100%
*Corrente finale • End current	min. ÷ 100%
Tipo innesco • Type of TIG arc ignition	HF/LIFT ARC
*Regolazione tempo di salita • Slope up	0-20sec
Regolazione tempo di discesa • Slope down	0-10sec /0-20sec*
Frequenza AC • AC Frequency	80-200 Hz/10-250 Hz*
Bilanciamento AC • AC Balancing	Regolabile /Adjustable 30% - 95%
Pulser • Pulser	SI /YES
*Corrente massima della pulsazione • Maximum pulsing current	5 - 200 A
*Corrente minima della pulsazione • Minimum pulsing current	5 - 200 A
*Frequenza Pulser DC • Pulser DC Frequency	1-350 Hz
*Frequenza Pulser AC • Pulser AC Frequency	Automatic
*Bilanciamento Pulser DC • Pulser DC Balancing	10% - 90%
*Bilanciamento Pulser AC • Pulser AC Balancing	Automatic
*Memorie • Program Memories	50

*Solo per il modello CDi • Only for CDi model

INDUSTRIE SERIES

WIG 250 HF AC/DC CDi

DDD115.250.T-E.06.00

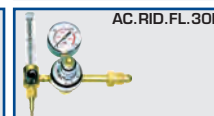
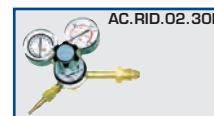
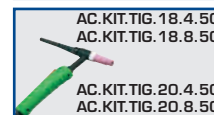

CE



PROCESSI / DUTY

Ciclo di lavoro TIG DC • TIG DC duty cycle	250 A – 70%
Corrente al 100 % • TIG DC output at 100% duty cycle	210 A
Ciclo di lavoro TIG AC • TIG AC duty cycle	250 A – 70%
Corrente al 100 % • TIG AC output at 100% duty cycle	210 A
Ciclo di lavoro elettrodo • Electrode duty cycle	250 A – 60%
Corrente al 100 % • Electrode output at 100% duty cycle	195 A

INVERTER

Tensione di alimentazione • Mains voltage	3X400V-10+15%
Frequenza • Frequency	50/60Hz
Tensione a vuoto • OCV	95 V
Potenza nominale elettrodo 100% • Electrode Nominal Power 100%	6,8 KW
Potenza nominale TIG DC 100% • TIG DC Nominal Power 100%	4,8 KW
Potenza nominale TIG AC 100% • TIG AC Nominal Power 100%	4,8 KW
Tensione d'arco elettrodo • Electrode arc voltage	20,2 – 30 V
Tensione d'arco TIG • TIG arc voltage	10,2 – 20 V
Corrente max • Max current	16 A
Fusibile di protezione • Protective Fuses	time lag 16 A ritardato
Fattore di potenza • Power factor	0,85
Grado di protezione • Degree of protection	IP 23 S
Classe d'isolamento • Insulation Class	F
Temperatura ambiente • Working temperature	-10°C+40°C
Dimensioni (mm) • Size (mm)	425x230x415
Peso (Kg) • Weight (Kg)	20,50

FUNZIONI / FEATURES

Regolazione elettrodo • Electrode output range	5 – 250 A
Hot start • Hot start	Regolabile /Adjustable
Arc force • Arc force	0-100%
Anti incollaggio • Antisticking	Automatic
Regolazione TIG • TIG output range	5 – 250 A
Comando consenso TIG • TIG control	2/4 T - STEP
Pre gas • Pre gas	0-30sec
Post gas • Post gas	0-20sec
Corrente di base • Base current	Regolabile /Adjustable
Corrente finale • End current	min. ÷ 100%
Tipo innesco • Type of TIG arc ignition	HF/LIFT ARC
Regolazione tempo di salita • Slope up	0-20sec
Regolazione tempo di discesa • Slope down	0-20sec
Frequenza AC • AC Frequency	Regolabile /Adjustable 10-250 Hz
Bilanciamento AC • AC Balancing	30% - 95%
Pulser • Pulser	SI /YES
Corrente massima della pulsazione • Maximum pulsing current	5 - 250 A
Corrente minima della pulsazione • Minimum pulsing current	5 - 250 A
Frequenza Pulser DC • Pulser DC Frequency	1-350 Hz
Frequenza Pulser AC • Pulser AC Frequency	Automatic
Bilanciamento Pulser DC • Pulser DC Balancing	10% - 90%
Bilanciamento Pulser AC • Pulser AC Balancing	Automatic
Memorie • Program Memories	50

INDUSTRIE SERIES

WIG 350 HF AC/DC

DDF115.350.T-E.01.00

WIG 350 HF AC/DC CDi

DDD115.350.T-E.01.00



CE

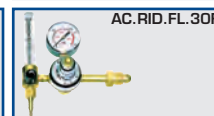
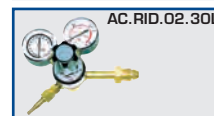
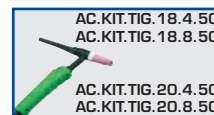

TIG AC/DC

PROCESSI / DUTY

Ciclo di lavoro TIG DC • TIG DC duty cycle	350 A – 70%
Corrente al 100 % • TIG DC output at 100% duty cycle	290 A
Ciclo di lavoro TIG AC • TIG AC duty cycle	350 A – 70%
Corrente al 100 % • TIG AC output at 100% duty cycle	290 A
Ciclo di lavoro elettrodo • Electrode duty cycle	350 A – 60%
Corrente al 100 % • Electrode output at 100% duty cycle	270 A

INVERTER

Tensione di alimentazione • Mains voltage	3X400V-10+15%
Frequenza • Frequency	50/60Hz
Tensione a vuoto • OCV	95 V
Potenza nominale elettrodo 100% • Electrode Nominal Power 100%	10,5 KW
Potenza nominale TIG DC 100% • TIG DC Nominal Power 100%	7,8 KW
Potenza nominale TIG AC 100% • TIG AC Nominal Power 100%	7,8 KW
Tensione d'arco elettrodo • Electrode arc voltage	20,2 – 34 V
Tensione d'arco TIG • TIG arc voltage	10,2 – 24 V
Corrente max • Max current	25 A
Fusibile di protezione • Protective Fuses	time lag 20 A ritardato
Fattore di potenza • Power factor	0,85
Grado di protezione • Degree of protection	IP 23 S
Classe d'isolamento • Insulation Class	F
Temperatura ambiente • Working temperature	-10°C+40°C
Dimensioni (mm) • Size (mm)	430x235x485/425x230x415*
Peso (Kg) • Weight (Kg)	23,80/20,50*

FUNZIONI / FEATURES

Regolazione elettrodo • Electrode output range	5 – 350 A
Hot start • Hot start	Regolabile /Adjustable
Arc force • Arc force	Automatic/0-100%*
Anti incollaggio • Antisticking	Automatic
Regolazione TIG • TIG output range	5 – 350 A
Comando consenso TIG • TIG control	2/4 T - STEP
*Pre gas • Pre gas	0-30sec
Post gas • Post gas	0-20sec /0-30sec*
Corrente di base • Base current	Regolabile /Adjustable
*Corrente finale • End current	min. ÷ 100%
Tipo innesco • Type of TIG arc ignition	HF/LIFT ARC
*Regolazione tempo di salita • Slope up	0-20sec
Regolazione tempo di discesa • Slope down	0-10sec /0-20sec*
Frequenza AC • AC Frequency	80-200 Hz Reg. /Adj. 10-250 Hz*
Bilanciamento AC • AC Balancing	30% - 95%
Pulser • Pulser	SI /YES*
*Corrente massima della pulsazione • Maximum pulsing current	5 - 350 A
*Corrente minima della pulsazione • Minimum pulsing current	5 - 350 A
*Frequenza Pulser DC • Pulser DC Frequency	1-350 Hz
*Frequenza Pulser AC • Pulser AC Frequency	Automatic
*Bilanciamento Pulser DC • Pulser DC Balancing	10% - 90%
*Bilanciamento Pulser AC • Pulser AC Balancing	Automatic
*Memorie • Program Memories	50

*Solo per il modello CDi • Only for CDi model

Accessori / Accessories TIG



AC.CM.25.50.4 massa/cable earth 25 mm² mt. 4 TX 50
 AC.CM.35.50.4 massa/cable earth 35 mm² mt. 4 TX 50
 AC.CM.50.50.4 massa/cable earth 50 mm² mt. 4 TX 50



CO.ARG.19011 bombola ARGON
 ARGON cylinder



AC.KIT.CAVI.25.50 kit cavi elettrodo 3+2 25 mm² TX50
 AC.KIT.CAVI.35.50 kit cavi elettrodo 3+2 35 mm² TX50
 AC.KIT.CAVI.50.50 kit cavi elettrodo 3+2 50 mm² TX50



AC.CO.DI.5 comando a distanza CD 500 mt. 5
 remote control box



AC.KIT.ELE.25.50 kit electrode set 3+2 mt. da 25 TX 50
 AC.KIT.ELE.35.50 kit electrode set 3+2 mt. da 35 TX 50
 AC.KIT.ELE.50.50 kit electrode set 3+2 mt. da 50 TX 50



AC.CO.PU.5 comando pulser CP 500 mt. 5
 pulser control box



MMCD00600 spina mobile 60059 NG
 male connector TX 50



AC.GBOX G-BOX



MMCH00570 connettore comando a distanza
 connettor 7 pin
 (remote control)



AC.RAF-230.01 unità di raffreddamento 230 V
 cooling unit 230 V
 AC.RAF-400.01 unità di raffreddamento 400 V
 cooling unit 400 V



MMCH00560 connettore consenso pulsante torcia
 connettor 4 pin (torch)



AC.CAR.SIN1 carrello con blocco saldatrici
 trolley



AC.KIT.TIG.20.4.50 torch 20.4 H₂O mt. 4 TX 50
 250A DC/220A AC @ 100%
 AC.KIT.TIG.20.8.50 torch 20.8 H₂O mt. 8 TX 50
 250A DC/220A AC @ 100%



AC.MAS.ELMRG maschera REGOLABILE
 ad elmetto autoscurante
 self darkening ADJUSTABLE helmet



AC.KIT.TIG.18.4.50 torch 18.4 H₂O mt. 4 TX 50
 320A DC/270A AC @ 100%
 AC.KIT.TIG.18.8.50 torch 18.8 H₂O mt. 8 TX 50
 320A DC/270A AC @ 100%



AC.CO.PE.8.01 comando a pedale CF 400 mt. 8
 foot control mt. 8



AC.KIT.TIG.17.4.50 torch 17.4 mt. 4 TX 50
 140A DC/125A AC @ 35%
 AC.KIT.TIG.17.8.50 torch 17.8 mt. 8 TX 50
 140A DC/125A AC @ 35%
 AC.KIT.TIG.26.4.50 torch 26.4 mt. 4 TX 50
 180A DC/150A AC @ 35%
 AC.KIT.TIG.26.8.50 torch 26.8 mt. 8 TX 50
 180A DC/150A AC @ 35%



AC.RID.02.30L riduttore a 2 manometri 801B-30L-AR
 gas pressure gauge



AC.RID.FL.30F riduttore con fluss. 801DB-30FAR-719
 flowmeter gas pressure



AC.RID.MAN.01 riduttore a 1 manometro per bombole usa
 e getta.
 gas pressure gauge for disposable gas
 cylinder.

LA SALDATURA MIG

Un generatore MIG (Metal Inert Gas) è formato da un generatore in corrente continua, un alimentatore filo talvolta incorporato, una torcia, una bobina di filo, un riduttore gas e una bombola di gas inerte (ARGON/CO₂ - 80/20%). Il filo, fungendo da materiale da apporto, viene spinto mediante un motore trainafilo attraverso il cavo della torcia. L'energia elettrica per l'arco è fornita dal generatore, la corrente di saldatura viene trasmessa attraverso la punta guidafile della torcia. Questa è normalmente collegata al positivo del generatore, mentre il materiale base è collegato al negativo tramite il cavo di massa; il circuito si chiude quando si innesca l'arco. Il gas protettivo, il cui compito principale è di proteggere l'arco ed il bagno di saldatura dall'azione ossidante dell'aria, fuoriesce dall'ugello della torcia. Poiché il filo avanza automaticamente mentre la torcia viene fatta avanzare a mano lungo la saldatura, il procedimento MIG è considerato un procedimento semiautomatico.

VANTAGGI

- maggiore produttività, poiché grazie all'apporto continuo di materiale fornito da una bobina di filo di vari diametri non occorre sostituire l'elettrodo
- nessuna scoria sul cordone di saldatura, grazie alla presenza del gas di protezione
- alta velocità di fusione del filo di apporto che garantisce saldature più veloci
- vasta gamma di spessori saldabili: da 0,5 mm in su grazie al basso apporto di calore.

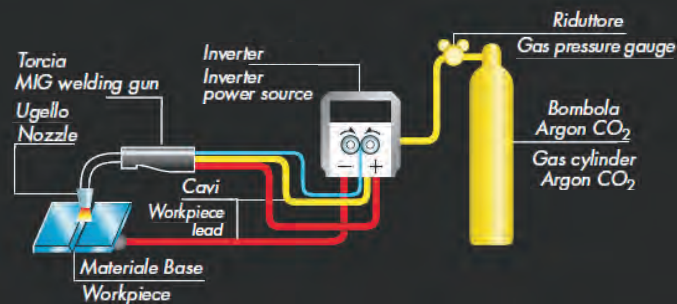

Esistono due principi di saldatura a filo animato:

- Senza Gas
- Con Gas,

Nel primo caso avremo un processo di saldatura simile a quello dell'elettrodo rivestito che quindi permette una saldatura a filo ma senza l'utilizzo del gas, ovviamente sarà una saldatura che presenta scoria da rimuovere; esso contiene disossidanti, scorificanti, stabilizzanti d'arco e elementi di lega. Nel secondo caso, invece, grazie all'utilizzo di un gas esterno ARGON CO₂ fornisce alla saldatura una maggior protezione del bagno con presenza sempre di scoria in quanto usiamo sempre fili rivestiti.

Per saldare con fili animati la torcia dell'inverter sarà collegata al negativo del generatore cambiando la polarità all'interno del vano porta bobina (spina mobile) e collegando il materiale base al polo positivo tramite il cavo massa.

VANTAGGI

Costo minore data la maggiore velocità di deposito e la maggiore intermittenza; non teme particolarmente l'umidità; facilmente adattabile alla saldatura automatica o robotizzata; saldatura più economica; ottima penetrazione; ottima tenacità del metallo depositato; minor sensibilità alla vernice; praticità per uso senza bombola gas.

MIG WELDING

The MIG (Metal Inert Gas) inverter welding system features a DC power source, a wire feeder (sometimes built-in), a welding gun, a wire spool, a gas pressure gauge and a gas cylinder (ARGON/CO₂ 80/20%). The wire is a filler metal that is pushed out by the wire-feeder rollers through the gun's hose. The power source generates current for the arc and this current is transmitted through the gun, connected to the positive pole of the inverter. The workpiece lead is connected to the negative pole of the inverter. Arc ignition closes the circuit. Output of shielding inert gas through the gun protects the welding arc and weld metal from atmospheric oxidation. MIG welding is a semi-automatic welding mode, since the wire output is automatic, while the welding gun is manually operated.

ADVANTAGES

- High throughput thanks to continuous filling-wire feeding, much higher than the electrode welding mode.
- No slagging thanks to the shielding gas
- Any thickness of work-piece from mm 0.5 onwards, thanks to the low temperature of the weld, can be welded.

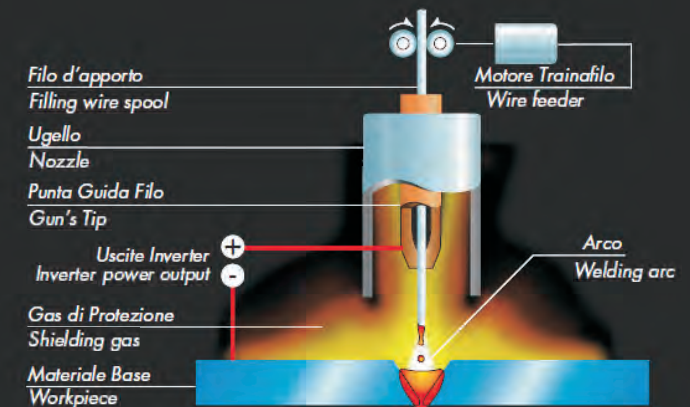

There are two types of flux core wire welding:

- Without gas;
- With gas;

The first type is similar to the coated electrode welding, which combines the wire welding features with the advantage of no gas. This welding produces slag that needs to be removed; it is composed of de-oxidants, slaggers, arc stabilizers and alloys.

The second type uses Argon/CO₂ gas and provides the welding seam a better protection. It produces a minor quantity of slag, that will always be produced with flux cored wires.

In order to weld the flux cored wire, the welding gun must be connected to the negative pole of the inverter by polarity exchange located nearby the wire feeder cassette. The weld is connected to the positive pole of the inverter.

ADVANTAGES

Higher deposition speed of the wire is economically valid;

- Moist is not damaging storage
- Easily used in mechanized welding
- Cost effective welding
- Good penetration
- High strength of the welded seam
- Can weld on painted surfaces
- No gas option eases logistics.

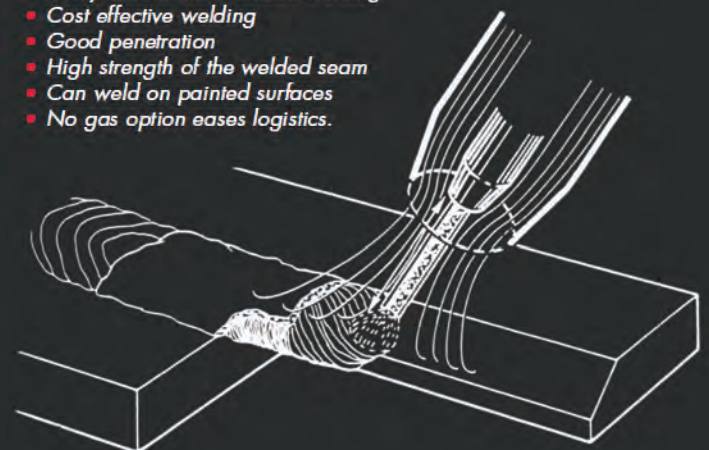

INDUSTRIE SERIES

MET 190 DCi ELECTRONIC CHOKE

DDF115.170.MTE.03.00



CE



PROCESSI / DUTY

Ciclo di lavoro MIG • MIG duty cycle	170 A – 50%
Corrente al 100 % • Output at 100% duty cycle	125 A
Ciclo di lavoro TIG DC • TIG DC duty cycle	170 A – 60%
Corrente al 100 % • TIG DC output at 100% duty cycle	130 A
Ciclo di lavoro elettrodo • Electrode duty cycle	170 A – 50%
Corrente al 100 % • Electrode output at 100% duty cycle	125 A

INVERTER

Tensione di alimentazione • Mains voltage	230V±10%
Frequenza • Frequency	50/60Hz
Tensione a vuoto • OCV	72 V
Potenza nominale elettrodo 100% • Electrode Nominal Power 100%	3,9 KW
Potenza nominale TIG DC 100% • TIG DC Nominal Power 100%	2,5 KW
Potenza nominale MIG 100% • MIG Nominal Power 100%	3,2 KW
Tensione d'arco elettrodo • Electrode arc voltage	20,2 – 26,8 V
Tensione d'arco TIG • TIG arc voltage	10,2 – 16,8 V
Tensione d'arco MIG • MIG arc voltage	15,0 – 22,5 V
Corrente max • Max current	29 A
Fusibile di protezione • Protective Fuses	time lag 16 A ritardato
Fattore di potenza • Power factor	0,85
Grado di protezione • Degree of protection	IP 23 S
Classe d'isolamento • Insulation Class	F
Temperatura ambiente • Working temperature	-10°C+40°C
Dimensioni (mm) • Size (mm)	520x200x370
Peso (Kg) • Weight (Kg)	17,50

FUNZIONI / FEATURES

Campo di regolazione elettrodo • Electrode output range	5 – 170 A
Campo di regolazione TIG DC • TIG DC output range	5 – 170 A
Campo di regolazione MIG • MIG output range	15 – 170 A
Hot start • Hot start	Automatic
Arc force • Arc force	Automatic
Electronic choke	Regolabile/Adjustable
Anti incollaggio • Antisticking	Automatic
Tipo innesco TIG DC • Type of arc ignition	LIFT
Tipo innesco MIG • Type of ignition MIG	2/4 STEP
Cambio polarità MIG • Polarity exchange MIG	SI / YES

FILLO / WIRE Ø

Pieno (mm) • Metal (mm)	0,6 - 0,8 - 1,0
Al (mm) • Al (mm)	1,0 - 1,2
Animato (mm) • Flux Core Wire (mm)	0,9 a/to 1,2
CU SI (mm)	0,8 - 1,0

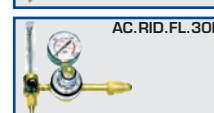
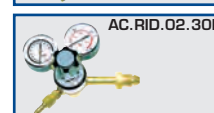

INDUSTRIE SERIES

MET 220 DCi ELECTRONIC CHOKE

DDF 115.200.MTE.03.00



CE

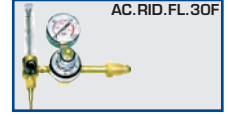
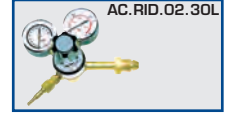

PROCESSI / DUTY

Ciclo di lavoro MIG • MIG duty cycle	200 A – 35%
Corrente al 100 % • Output at 100% duty cycle	130 A
Ciclo di lavoro TIG DC • TIG DC duty cycle	200 A – 40%
Corrente al 100 % • TIG DC output at 100% duty cycle	140 A
Ciclo di lavoro elettrodo • Electrode duty cycle	200 A – 35%
Corrente al 100 % • Electrode output at 100% duty cycle	130 A

INVERTER

Tensione di alimentazione • Mains voltage	230V±10%
Frequenza • Frequency	50/60Hz
Tensione a vuoto • OCV	72 V
Potenza nominale elettrodo 100% • Electrode Nominal Power 100%	4,1 KW
Potenza nominale TIG DC 100% • TIG DC Nominal Power 100%	2,7 KW
Potenza nominale MIG 100% • MIG Nominal Power 100%	3,3 KW
Tensione d'arco elettrodo • Electrode arc voltage	20,2 – 28,0 V
Tensione d'arco TIG • TIG arc voltage	10,2 – 18,0 V
Tensione d'arco MIG • MIG arc voltage	15,0 – 24,0 V
Corrente max • Max current	36 A
Fusibile di protezione • Protective Fuses	time lag 20 A ritardato
Fattore di potenza • Power factor	0,85
Grado di protezione • Degree of protection	IP 23 S
Classe d'isolamento • Insulation Class	F
Temperatura ambiente • Working temperature	-10°C+40°C
Dimensioni (mm) • Size (mm)	520x200x370
Peso (Kg) • Weight (Kg)	18,50

FUNZIONI / FEATURES

Campo di regolazione elettrodo • Electrode output range	5 – 200 A
Campo di regolazione TIG DC • TIG DC output range	5 – 200 A
Campo di regolazione MIG • MIG output range	15 – 200 A
Hot start • Hot start	Automatic
Arc force • Arc force	Automatic
Electronic choke	Regolabile/Adjustable
Anti incollaggio • Antisticking	Automatic
Tipo innesco TIG DC • Type of arc ignition	LIFT
Tipo innesco MIG • Type of ignition MIG	2/4 STEP
Cambio polarità MIG • Polarity exchange MIG	SI / YES

FILO / WIRE Ø

Pieno (mm) • Metal (mm)	0,6 - 0,8 - 1,0
Al (mm) • Al (mm)	1,0 - 1,2
Animato (mm) • Flux Core Wire (mm)	0,9 a/to 1,2
CU SI (mm)	0,8 - 1,0

MIG/MAG

INDUSTRIE SERIES

MET 190 CDi SYNERGIC ELECTRONIC CHOKE

DDD115.170.MTE.01.00



CE

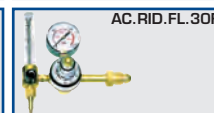
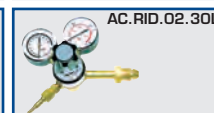

PROCESSI / DUTY

Ciclo di lavoro MIG • MIG duty cycle	170 A – 50%
Corrente al 100 % • Output at 100% duty cycle	125 A
Ciclo di lavoro TIG DC • TIG DC duty cycle	170 A – 60%
Corrente al 100 % • TIG DC output at 100% duty cycle	130 A
Ciclo di lavoro elettrodo • Electrode duty cycle	170 A – 50%
Corrente al 100 % • Electrode output at 100% duty cycle	125 A

INVERTER

Tensione di alimentazione • Mains voltage	230V±10%
Frequenza • Frequency	50/60Hz
Tensione a vuoto • OCV	58 V
Potenza nominale elettrodo 100% • Electrode Nominal Power 100%	3,9 KW
Potenza nominale TIG DC 100% • TIG DC Nominal Power 100%	2,5 KW
Potenza nominale MIG 100% • MIG Nominal Power 100%	3,2 KW
Tensione d'arco elettrodo • Electrode arc voltage	20,2 – 26,8 V
Tensione d'arco TIG • TIG arc voltage	10,2 – 16,8 V
Tensione d'arco MIG • MIG arc voltage	15,0 – 22,5 V
Corrente max • Max current	29 A
Fusibile di protezione • Protective Fuses	time lag 16 A ritardato
Fattore di potenza • Power factor	0,85
Grado di protezione • Degree of protection	IP 23 S
Classe d'isolamento • Insulation Class	F
Temperatura ambiente • Working temperature	-10°C+40°C
Dimensioni (mm) • Size (mm)	520x200x370
Peso (Kg) • Weight (Kg)	17,50

FUNZIONI / FEATURES

Campo di regolazione elettrodo • Electrode output range	5 – 170 A
Campo di regolazione TIG DC • TIG DC output range	5 – 170 A
Campo di regolazione MIG • MIG output range	15 – 170 A
Hot start • Hot start	Automatic
Arc force • Arc force	Automatic
Electronic choke	Regolabile/Adjustable
Anti incollaggio • Antisticking	Automatic
Tipo innesco TIG DC • Type of arc ignition	LIFT
Tipo innesco MIG • Type of ignition MIG	2/4 STEP
Cambio polarità MIG • Polarity exchange MIG	SI / YES
SOFT - START MIG	SI / YES
PROGRAM MEMORY	50
Trainafile 4 rulli dentati • 4 gear wheels wire feeder	SI / YES
BURN - BACK MIG	SI / YES
SYNERGIC ARC MIG	SI / YES
SPOT MIG	SI / YES

FILO / WIRE Ø

Pieno (mm) • Metal (mm)	0,6 - 0,8 - 1,0
Al (mm) • Al (mm)	1,0 - 1,2
Animato (mm) • Flux Core Wire (mm)	0,9 a/to 1,2
CU SI (mm)	0,8 - 1,0

INDUSTRIE SERIES

MET 220 CDi SYNERGIC ELECTRONIC CHOKE

DDD115.200.MTE.03.00



CE

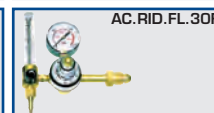
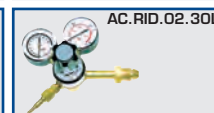

PROCESSI / DUTY

Ciclo di lavoro MIG • MIG duty cycle	200 A – 35%
Corrente al 100 % • Output at 100% duty cycle	130 A
Ciclo di lavoro TIG DC • TIG DC duty cycle	200 A – 40%
Corrente al 100 % • TIG DC output at 100% duty cycle	140 A
Ciclo di lavoro elettrodo • Electrode duty cycle	200 A – 35%
Corrente al 100 % • Electrode output at 100% duty cycle	130 A

INVERTER

Tensione di alimentazione • Mains voltage	230V±10%
Frequenza • Frequency	50/60Hz
Tensione a vuoto • OCV	58 V
Potenza nominale elettrodo 100% • Electrode Nominal Power 100%	4,1 KW
Potenza nominale TIG DC 100% • TIG DC Nominal Power 100%	2,7 KW
Potenza nominale MIG 100% • MIG Nominal Power 100%	3,3 KW
Tensione d'arco elettrodo • Electrode arc voltage	20,2 – 28,0 V
Tensione d'arco TIG • TIG arc voltage	10,2 – 18,0 V
Tensione d'arco MIG • MIG arc voltage	15,0 – 24,0 V
Corrente max • Max current	36 A
Fusibile di protezione • Protective Fuses	time lag 20 A ritardato
Fattore di potenza • Power factor	0,85
Grado di protezione • Degree of protection	IP 23 S
Classe d'isolamento • Insulation Class	F
Temperatura ambiente • Working temperature	-10°C+40°C
Dimensioni (mm) • Size (mm)	520x200x370
Peso (Kg) • Weight (Kg)	18,50

FUNZIONI / FEATURES

Campo di regolazione elettrodo • Electrode output range	5 – 200 A
Campo di regolazione TIG DC • TIG DC output range	5 – 200 A
Campo di regolazione MIG • MIG output range	15 – 200 A
Hot start • Hot start	Automatic
Arc force • Arc force	Automatic
Electronic choke	Regolabile/Adjustable
Anti incollaggio • Antisticking	Automatic
Tipo innesco TIG DC • Type of arc ignition	LIFT
Tipo innesco MIG • Type of ignition MIG	2/4 STEP
Cambio polarità MIG • Polarity exchange MIG	SI / YES
SOFT - START MIG	SI / YES
PROGRAM MEMORY	50
Trainafile 4 rulli dentati • 4 gear wheels wire feeder	SI / YES
BURN - BACK MIG	SI / YES
SYNERGIC ARC MIG	SI / YES
SPOT MIG	SI / YES

FILO / WIRE Ø

Pieno (mm) • Metal (mm)	0,6 - 0,8 - 1,0
Al (mm) • Al (mm)	1,0 - 1,2
Animato (mm) • Flux Core Wire (mm)	0,9 a/to 1,2
CU SI (mm)	0,8 - 1,0

MIG/MAG

INDUSTRIE SERIES

MET 270 DCi ELECTRONIC CHOKE

DDF115.270.MTE.01.00



CE

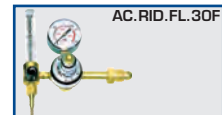
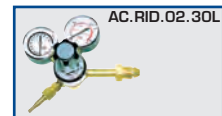
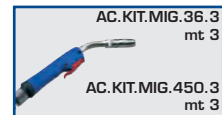

PROCESSI / DUTY

Ciclo di lavoro MIG • MIG duty cycle	250 A – 50%
Corrente al 100 % • Output at 100% duty cycle	180 A
Ciclo di lavoro TIG DC • TIG DC duty cycle	250 A – 70%
Corrente al 100 % • TIG DC output at 100% duty cycle	210 A
Ciclo di lavoro elettrodo • Electrode duty cycle	250 A – 60%
Corrente al 100 % • Electrode output at 100% duty cycle	195 A

INVERTER

Tensione di alimentazione • Mains voltage	3x400V-10+15%
Frequenza • Frequency	50/60Hz
Tensione a vuoto • OCV	72 V
Potenza nominale elettrodo 100% • Electrode Nominal Power 100%	6,8 KW
Potenza nominale TIG DC 100% • TIG DC Nominal Power 100%	4,8 KW
Potenza nominale MIG 100% • MIG Nominal Power 100%	5,4 KW
Tensione d'arco elettrodo • Electrode arc voltage	20,2 – 30,0 V
Tensione d'arco TIG • TIG arc voltage	10,2 – 20,0 V
Tensione d'arco MIG • MIG arc voltage	15,0 – 28,5 V
Corrente max • Max current	16 A
Fusibile di protezione • Protective Fuses	time lag 16 A ritardato
Fattore di potenza • Power factor	0,85
Grado di protezione • Degree of protection	IP 23 S
Classe d'isolamento • Insulation Class	F
Temperatura ambiente • Working temperature	-10°C+40°C
Dimensioni (mm) • Size (mm)	760x475x228
Peso (Kg) • Weight (Kg)	24,50

FUNZIONI / FEATURES

Campo di regolazione elettrodo • Electrode output range	5 – 250 A
Campo di regolazione TIG DC • TIG DC output range	5 – 250 A
Campo di regolazione MIG • MIG output range	15 – 270 A
Hot start • Hot start	Automatic
Arc force • Arc force	Automatic
Electronic choke	Regolabile/Adjustable
Anti incollaggio • Antisticking	Automatic
Tipo innesco TIG DC • Type of arc ignition	LIFT

FILO / WIRE Ø

Pieno (mm) • Metal (mm)	0,8 - 1,0 - 1,2
Al (mm) • Al (mm)	1,0 - 1,2
Animato (mm) • Flux Core Wire (mm) con GAS/with GAS	0,9 a/to 1,2
CU SI (mm)	0,8 - 1,0

INDUSTRIE SERIES

MET 400 DCi ELECTRONIC CHOKE

DDF 115.400.MTE.01.00

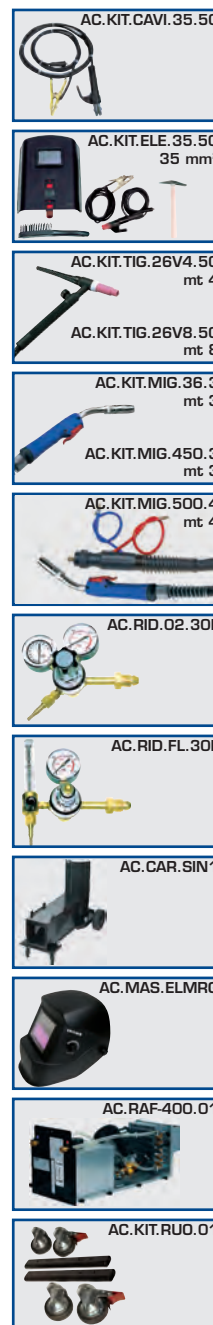

CE



PROCESSI / DUTY

Ciclo di lavoro MIG • MIG duty cycle	380 A – 30%
Corrente al 100 % • Output at 100% duty cycle	230 A
Ciclo di lavoro TIG DC • TIG DC duty cycle	320 A – 60%
Corrente al 100 % • TIG DC output at 100% duty cycle	260 A
Ciclo di lavoro elettrodo • Electrode duty cycle	320 A – 40%
Corrente al 100 % • Electrode output at 100% duty cycle	230 A

INVERTER

Tensione di alimentazione • Mains voltage	3x400V-10+15%
Frequenza • Frequency	50/60Hz
Tensione a vuoto • OCV	72 V
Potenza nominale elettrodo 100% • Electrode Nominal Power 100%	8,3 KW
Potenza nominale TIG DC 100% • TIG DC Nominal Power 100%	6,6 KW
Potenza nominale MIG 100% • MIG Nominal Power 100%	7,3 KW
Tensione d'arco elettrodo • Electrode arc voltage	20,2 – 32,8 V
Tensione d'arco TIG • TIG arc voltage	10,2 – 22,8 V
Tensione d'arco MIG • MIG arc voltage	15,0 – 33 V
Corrente max • Max current	27 A
Fusibile di protezione • Protective Fuses	time lag 20 A ritardato
Fattore di potenza • Power factor	0,85
Grado di protezione • Degree of protection	IP 23 S
Classe d'isolamento • Insulation Class	F
Temperatura ambiente • Working temperature	-10°C+40°C
Dimensioni (mm) • Size (mm)	760x475x228
Peso (Kg) • Weight (Kg)	24,50

FUNZIONI / FEATURES

Campo di regolazione elettrodo • Electrode output range	5 – 320 A
Campo di regolazione TIG DC • TIG DC output range	5 – 320 A
Campo di regolazione MIG • MIG output range	15 – 400 A
Hot start • Hot start	Automatic
Arc force • Arc force	Automatic
Electronic choke	Regolabile/Adjustable
Anti incollaggio • Antisticking	Automatic
Tipo innesco TIG DC • Type of arc ignition	LIFT

FILO / WIRE Ø

Pieno (mm) • Metal (mm)	0,8 - 1,0 - 1,2
Al (mm) • Al (mm)	1,0 - 1,2
Animato (mm) • Flux Core Wire (mm) con GAS/with GAS	0,9 a/to 1,2
CU SI (mm)	0,8 - 1,0

MIG/MAG

Accessori MIG



AC.CM.25.50.4 massa/cable earth 25 mm² mt. 4 TX 50
 AC.CM.35.50.4 massa/cable earth 35 mm² mt. 4 TX 50
 AC.CM.50.50.4 massa/cable earth 50 mm² mt. 4 TX 50



AC.CO.DI.5 comando a distanza CD 500 mt. 5 remote control box



AC.KIT.CAVI.25.50 kit cavi elettrodo 3+2 25 mm² TX50
 AC.KIT.CAVI.35.50 kit cavi elettrodo 3+2 35 mm² TX50
 AC.KIT.CAVI.50.50 kit cavi elettrodo 3+2 50 mm² TX50



AC.GBOX G-BOX



AC.KIT.ELE.25.50 kit electrode set 3+2 mt. da 25 TX 50
 AC.KIT.ELE.35.50 kit electrode set 3+2 mt. da 35 TX 50
 AC.KIT.ELE.50.50 kit electrode set 3+2 mt. da 50 TX 50



AC.RAF-230.01 unità di raffreddamento 230 V cooling unit 230 V
 AC.RAF-400.01 unità di raffreddamento 400 V cooling unit 400 V



MMCD00600 spina mobile 60059 NG male connector TX 50



AC.CAR.SIN1 carrello con blocco saldatrici trolley



MMCH00570 connettore comando a distanza connector 7 pin



AC.KIT.MIG.25.3 torch ergoplus 25.3 mt. 3
 AC.KIT.MIG.36.3 torch ergoplus 36.3 mt. 3
 AC.KIT.MIG.450.3 torch ergoplus 450 mt. 3



MMCH00560 connettore consenso pulsante torcia connector 4 pin



AC.KIT.MIG.500.4 torch ergoplus H₂O mt. 4



CO.ARG.19011 bombola ARGON ARGON cylinder
 CO.MIS.19012 bombola ARGON CO² 80 - 20% disposable ARGON / CO² blend 80 - 20%



CO.BOB.FE.06-05 bobina filo Ø 0,6 steel filling wire 5 Kg spool
 CO.BOB.FE.08-05 bobina filo Ø 0,8 steel filling wire 5 Kg spool
 CO.BOB.AN.09-045 bob. filo anim. Ø 0,9 flux core wire 4,5Kg spool



AC.RID.MAN.01 riduttore a 1 manometro per bombole usa e getta. gas pressure gauge for disposable gas cylinder.



MET 190
 MET 190 SYN
 MET 220
 MET 220 SYN
 diam. 30mm

RI.RULLO.299.FE.02 rullo per filo Ø 0,6/0,8-V metal wire
 RI.RULLO.299.FE.01 rullo per filo Ø 0,8/1,0-V metal wire
 RI.RULLO.299.FA.00 filo Ø 0,9/1,2-VK animato, flux core
 RI.RULLO.299.AL.00 filo Ø 1,0/1,2-U alluminio, Al



AC.RID.02.30L riduttore a 2 manometri 801B-30L-AR gas pressure gauge



MET 270
 MET 350
 diam. 30mm

RI.RULLO.299.FE.02 rullo per filo Ø 0,6/0,8-V metal wire
 RI.RULLO.299.FE.01 rullo per filo Ø 0,8/1,0-V metal wire
 RI.RULLO.299.FE.00 rullo per filo Ø 1,0/1,2-V metal wire
 RI.RULLO.299.FA.00 filo Ø 0,9/1,2-VK animato, flux core
 RI.RULLO.299.AL.00 filo Ø 1,0/1,2-U alluminio, Al



AC.RID.FL.30F riduttore con fluss. 801DB-30FAR-719 flowmeter gas pressure



AC.MAS.ELMRG maschera manuale con visore CS 110 mask automatic



KIT.CAMBIO.POL.MET Kit cambio polarità filo animato NO GAS

Disponibile per
 ERGUS MET 270DCi
 ERGUS MET 400DCi



AC.CO.PE.8.01 comando a pedale CF 400 mt. 8 foot control mt. 8



AC.KIT.TIG.17V4.25 torch 17V4 C/manual mt. 4 TX 25 140A DC/125A AC @ 35%
 AC.KIT.TIG.17V8.25 torch 17V8 C/manual mt. 8 TX 25 140A DC/125A AC @ 35%
 AC.KIT.TIG.17V4.50 torch 17V4 C/manual mt. 4 TX 50 140A DC/125A AC @ 35%
 AC.KIT.TIG.17V8.50 torch 17V8 C/manual mt. 8 TX 50 140A DC/125A AC @ 35%
 AC.KIT.TIG.26V4.50 torch 26V4 C/manual mt. 4 TX 50 180A DC/150A AC @ 35%
 AC.KIT.TIG.26V8.50 torch 26V8 C/manual mt. 8 TX 50 180A DC/150A AC @ 35%

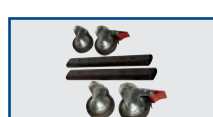

AC.KIT.RUO.01 kit ruote per MET270-350 - 220 Multipulse wheels kit for MET270-350 - 220 Multipulse

IL TAGLIO PLASMA

È un procedimento che consente il taglio di tutti i materiali conduttori come:

- Ferro
- Inox
- Alluminio
- Ottone
- Rame, ecc...

Il Taglio Plasma è utilizzato per tagliare velocemente tutti i materiali conduttori, senza creare bave e senza deformare neppure le lamiere più sottili. Tutto questo grazie alle altissime temperature (circa 20.000°C) dell'arco plasma, che viene creato sfruttando l'azoto presente nell'aria (circa il 78%) e la corrente erogata dal generatore.

Questi due elementi vengono convogliati nel foro calibrato dell'ugello della torcia plasma, formando l'arco concentrato e rigido che consente il taglio dei metalli.

Nel Taglio Plasma la partenza può essere effettuata a contatto che, pur mantenendo una buona qualità di innesco, ne rallenta l'operazione; inoltre non è utilizzabile su lamiere verniciate, plastificate e molto ossidate.

In alternativa, la partenza può essere effettuata ad arco pilota, innescato grazie alla presenza dell'alta frequenza (HF), che consente di creare l'arco di taglio sia partendo a distanza dal pezzo, sia a contatto, poiché lo stesso perfora l'isolamento creato da vernici, ossidi e plastificazioni; in questo modo sono ovviati tutti i problemi creati dalla partenza a contatto senza l'arco pilota.

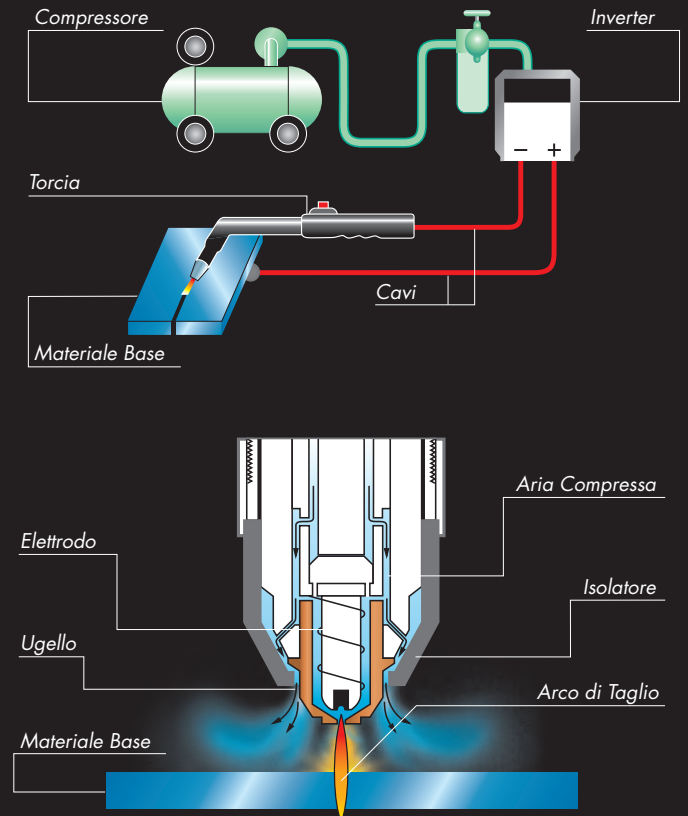

AIR PLASMA CUTTING

Several ferrous and non ferrous metals can be cut with our plasma cutting inverters:

- Steel
- Stainless steel
- Aluminium
- Brass
- Copper etc.

The benefits from plasma cutting are quick cutting, neat, chip-free edges and no sheet warping even with thin metal sheets. This can be achieved thanks to the very high plasma arc temperature: about 20.000° C (36.000° F). The plasma arc is mostly high pressure polarised air jet. It is obtained from an air compressor and a power source capable of polarising compressed air (consisting of about 78% Nitrogen). Polarised air comes out from a calibrated nozzle of the plasma torch which concentrates the cutting jet on the workpiece.

There are several systems to create and ignite the cutting jet, for example, by contact between the plasma torch and the workpiece. In this case, the workpiece surface must have no grease, paint or other coatings, to allow for electric contact between the poles and ignite the arc. Another system is by pilot arc, which maintains the arc ignited with the built-in HF system, which ensures the initial penetration into the workpiece, thus guaranteeing the electric contact that will maintain the cutting arc. The second system is quicker and safer.

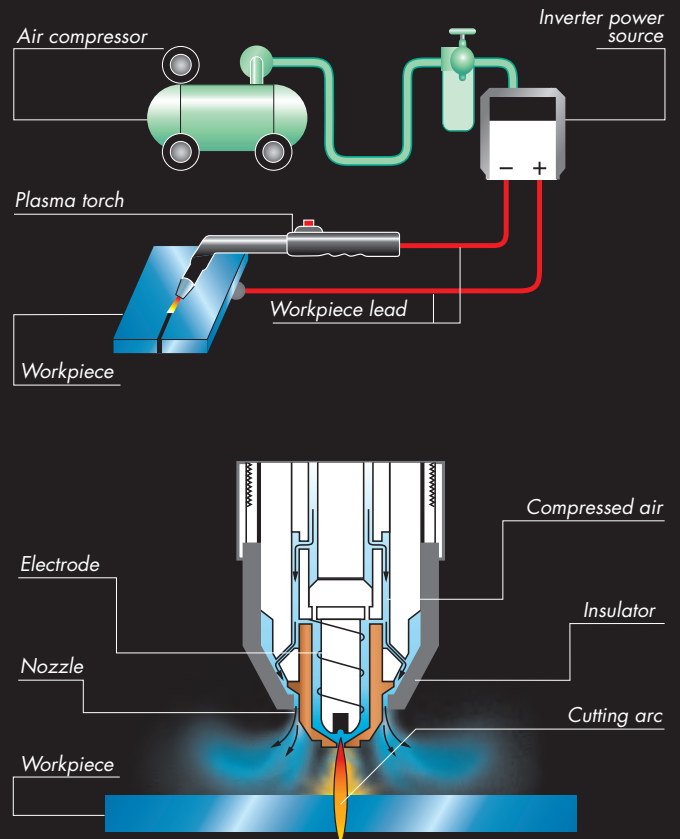

ADV SERIES

TYPHOON BIFLUX 25/35 G-PROT

DDF115.035.PLA.03.00



CONSUMABILI TORCIA PT-25C
PLASMA TORCH PT-25C CONSUMABLES



Ferro • Carbon steel
↓ 10 mm



Ferro • Carbon steel
↓ 6 mm



PROCESSI / DUTY	EXTERNAL	BUILT - IN
Ciclo di lavoro Plasma • Plasma duty cycle	35 A – 25%	25 A – 35%
Corrente al 100 % • Plasma output at 100% duty cycle	20 A	20 A

INVERTER	EXTERNAL	BUILT - IN
Tensione di alimentazione • Mains voltage	230V±10%	230V±10%
Frequenza • Frequency	50/60Hz	50/60Hz
Tensione a vuoto • OCV	270 V	270 V
Potenza nominale Plasma 100% • Plasma Nominal Power 100%	2,2 KW	2,4 KW
Tensione d'arco plasma • Plasma arc voltage	86 - 94 V	85 - 90 V
Corrente max • Max current	21 A	18 A
Fusibile di protezione ritardato • Protective Fuses time lag	16 A	16 A
Fattore di potenza • Power factor	0,85	0,85
Grado di protezione • Degree of protection	IP 23 S	IP 23 S
Classe d'isolamento • Insulation Class	F	F
Temperatura ambiente • Working temperature	-10°C+40°C	-10°C+40°C
Dimensioni (mm) • Size (mm)	470x150x245	470x150x245
Peso (Kg) • Weight (Kg)	10,00	10,00

FUNZIONI / FEATURES	EXTERNAL	BUILT - IN
Campo di regolazione Plasma • Plasma output range	12 – 35 A	12 – 25 A
Tipo innesco • Type of arc ignition	PILOT ARC	PILOT ARC

PRESTAZIONI / CUTTING PERFORMANCE	EXTERNAL	BUILT - IN
Divisione (mm) • Severance (mm)	12	10
Taglio qualità (mm) • Quality cut (mm)	10	6

ADV SERIES

CUTVERT 35/50

DDF115.035.PLA.02.00



CE



PROCESSI / DUTY

Ciclo di lavoro Plasma • Plasma duty cycle	35 A – 50%
Corrente al 100 % • Plasma output at 100% duty cycle	22 A

INVERTER

Tensione di alimentazione • Mains voltage	230V±10%
Frequenza • Frequency	50/60Hz
Tensione a vuoto • OCV	270 V
Potenza nominale Plasma 100% • Plasma Nominal Power 100%	2,4 KW
Tensione d'arco plasma • Plasma arc voltage	86 V – 94 V
Corrente max • Max current	21 A
Fusibile di protezione • Protective Fuses	time lag 16 A ritardato
Fattore di potenza • Power factor	0,85
Grado di protezione • Degree of protection	IP 23 S
Classe d'isolamento • Insulation Class	F
Temperatura ambiente • Working temperature	-10°C+40°C
Dimensioni (mm) • Size (mm)	475x150x220
Peso (Kg) • Weight (Kg)	8,00

FUNZIONI / FEATURES

Campo di regolazione Plasma • Plasma output range	15 – 35 A
Tipo innesco • Type of arc ignition	PILOT ARC

PRESTAZIONI / CUTTING PERFORMANCE

Divisione (mm) • Severance (mm)	12
Taglio qualità (mm) • Quality cut (mm)	10
Portata aria (lt/min) • Air flow (lt/min)	max 100
Pressione (bar) • Pressure (bar)	3,5 - 4,0

CONSUMABILI TORCIA PT-40 PLASMA TORCH PT-40 CONSUMABLES



ACCESSORI ACCESSORIES



Ferro • Carbon steel
±10 mm



PLASMA

INDUSTRIE SERIES

PLASMA 404 DP

DDF 115.040.PLA.03.00



TORCIA A51

PLASMA TORCH A51

CONSUMABILI STANDARD STANDARD CONSUMABLES



CONSUMABILI PROLUNGATI LONG CONSUMABLES

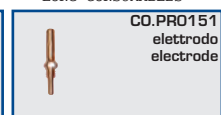

CE



PROCESSI / DUTY

Ciclo di lavoro Plasma • Plasma duty cycle	40 A – 40%
Corrente al 100 % • Plasma output at 100% duty cycle	25 A

INVERTER

Tensione di alimentazione • Mains voltage	230V±10%
Frequenza • Frequency	50/60Hz
Tensione a vuoto • OCV	270 V
Potenza nominale Plasma 100% • Plasma Nominal Power 100%	2,8 KW
Tensione d'arco plasma • Plasma arc voltage	86 V – 96 V
Corrente max • Max current	25 A
Fusibile di protezione • Protective Fuses	time lag 16 A ritardato
Fattore di potenza • Power factor	0,85
Grado di protezione • Degree of protection	IP 23 S
Classe d'isolamento • Insulation Class	F
Temperatura ambiente • Working temperature	-10°C+40°C
Dimensioni (mm) • Size (mm)	460x180x220
Peso (Kg) • Weight (Kg)	12,10

ACCESSORI ACCESSORIES



FUNZIONI / FEATURES

Campo di regolazione Plasma • Plasma output range	15 – 40 A
Tipo innesco • Type of arc ignition	PILOT ARC+HF

PRESTAZIONI / CUTTING PERFORMANCE

Divisione (mm) • Severance (mm)	14
Taglio qualità (mm) • Quality cut (mm)	12
Portata aria (lt/min) • Air flow (lt/min)	max 120
Pressione (bar) • Pressure (bar)	5,0

Ferro • Carbon steel

12 mm

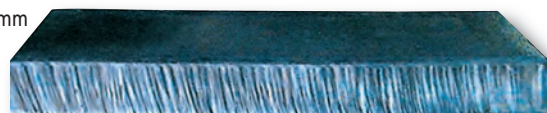

INDUSTRIE SERIES

PLASMA 707 DP

DDF 115.070.PLA.03.00



CE



PROCESSI / DUTY

Ciclo di lavoro Plasma • Plasma duty cycle	70 A – 60%
Corrente al 100 % • Plasma output at 100% duty cycle	55 A

INVERTER

Tensione di alimentazione • Mains voltage	3x400V-10+15%
Frequenza • Frequency	50/60Hz
Tensione a vuoto • OCV	380 V
Potenza nominale Plasma 100% • Plasma Nominal Power 100%	8,4 KW
Tensione d'arco plasma • Plasma arc voltage	110 V – 128 V
Corrente max • Max current	19 A
Fusibile di protezione • Protective Fuses	time lag 16 A ritardato
Fattore di potenza • Power factor	0,85
Grado di protezione • Degree of protection	IP 23 S
Classe d'isolamento • Insulation Class	F
Temperatura ambiente • Working temperature	-10°C+40°C
Dimensioni (mm) • Size (mm)	470x180x225
Peso (Kg) • Weight (Kg)	15,65 Kg

FUNZIONI / FEATURES

Campo di regolazione Plasma • Plasma output range	26 – 70A
Tipo innesco • Type of arc ignition	PILOT ARC+HF

PRESTAZIONI / CUTTING PERFORMANCE

Divisione (mm) • Severance (mm)	25
Taglio qualità (mm) • Quality cut (mm)	20
Portata aria (lt/min) • Air flow (lt/min)	max 200
Pressione (bar) • Pressure (bar)	5,0

Ferro • Carbon steel
 \pm 20 mm

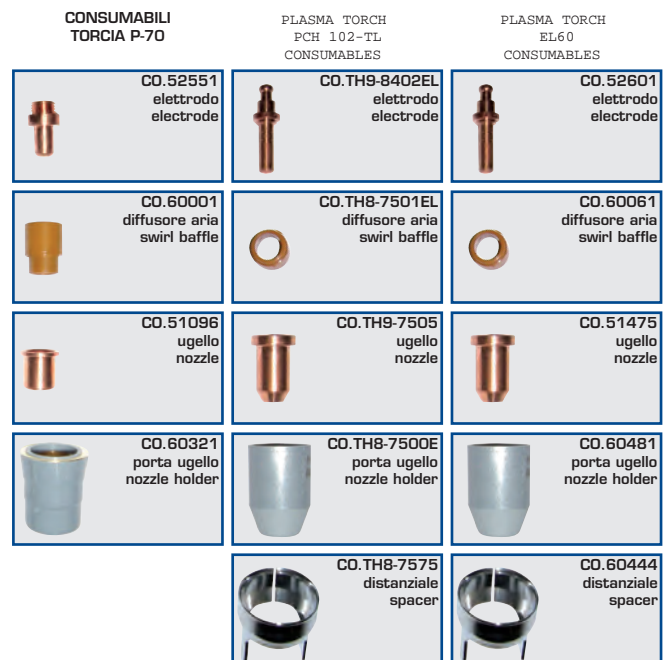

PLASMA

INDUSTRIE SERIES

PLASMA 909 DP

DDF115.090.PLA.01.00



CE



PROCESSI / DUTY

Ciclo di lavoro Plasma • Plasma duty cycle	90 A – 40%
Corrente al 100 % • Plasma output at 100% duty cycle	55 A

INVERTER

Tensione di alimentazione • Mains voltage	3x400V-10+15%
Frequenza • Frequency	50/60Hz
Tensione a vuoto • OCV	250 V
Potenza nominale Plasma 100% • Plasma Nominal Power 100%	8,4 KW
Tensione d'arco plasma • Plasma arc voltage	110 V – 136 V
Corrente max • Max current	26 A
Fusibile di protezione • Protective Fuses	time lag 25 A ritardato
Fattore di potenza • Power factor	0,85
Grado di protezione • Degree of protection	IP 23 S
Classe d'isolamento • Insulation Class	F
Temperatura ambiente • Working temperature	-10°C+40°C
Dimensioni (mm) • Size (mm)	420x180x270
Peso (Kg) • Weight (Kg)	16,60 Kg

FUNZIONI / FEATURES

Campo di regolazione Plasma • Plasma output range	26 – 90 A
Tipo innesco • Type of arc ignition	PILOT ARC+HF

PRESTAZIONI / CUTTING PERFORMANCE

Divisione (mm) • Severance (mm)	30
Taglio qualità (mm) • Quality cut (mm)	25
Portata aria (lt/min) • Air flow (lt/min)	max 200
Pressione (bar) • Pressure (bar)	5,0

KIT TORCIA PCH102
PCH102 KIT TORCH

KIT TORCIA EL60
EL60 KIT TORCH



PLASMA TORCH
PCH 102-TL
CONSUMABLES

PLASMA TORCH
EL60
CONSUMABLES

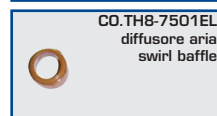

Ferro • Carbon steel

± 25 mm



INDUSTRIE SERIES

PLASMA 120 DP

DDF115.120.PLA.01.00



KIT TORCIA A141
A141 KIT TORCH



KIT TORCIA EL60
EL60 KIT TORCH



PLASMA TORCH
A141
CONSUMABLES



CO.PR0101
elettrodo
electrode

PLASMA TORCH
EL-60
CONSUMABLES

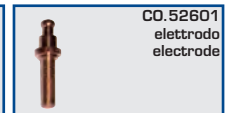

CO.52601
elettrodo
electrode



CO.PE0101
diffusore aria
swirl baffle



CO.60061
diffusore aria
swirl baffle



CO.PD0101-17
ugello
nozzle

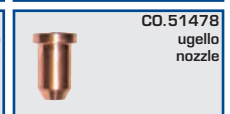

CO.51478
ugello
nozzle



CO.PC0101
porta ugello
nozzle holder



CO.60481
porta ugello
nozzle holder



CO.CV0011
distanziale
spacer



CO.60444
distanziale
spacer

PROCESSI / DUTY

Ciclo di lavoro Plasma • Plasma duty cycle	120 A – 40%
Corrente al 100 % • Plasma output at 100% duty cycle	80 A

INVERTER

Tensione di alimentazione • Mains voltage	3x400V-10+15%
Frequenza • Frequency	50/60Hz
Tensione a vuoto • OCV	450 V
Potenza nominale Plasma 100% • Plasma Nominal Power 100%	13,2 KW
Tensione d'arco plasma • Plasma arc voltage	110 V – 148 V
Corrente max • Max current	38 A
Fusibile di protezione • Protective Fuses	time lag 40 A ritardato
Fattore di potenza • Power factor	0,85
Grado di protezione • Degree of protection	IP 23 S
Classe d'isolamento • Insulation Class	F
Temperatura ambiente • Working temperature	-10°C+40°C
Dimensioni (mm) • Size (mm)	610x230x460
Peso (Kg) • Weight (Kg)	32,00 Kg

FUNZIONI / FEATURES

Campo di regolazione Plasma • Plasma output range	25 – 120 A
Tipo innesco • Type of arc ignition	PILOT ARC+HF

PRESTAZIONI / CUTTING PERFORMANCE

Divisione (mm) • Severance (mm)	50
Taglio qualità (mm) • Quality cut (mm)	40
Portata aria (lt/min) • Air flow (lt/min)	max 200
Pressione (bar) • Pressure (bar)	6,0

Ferro • Carbon steel \pm 40 mm



PLASMA

INDUSTRIE SERIES

PLASMA 105 DP SMART ARC

DDF115.105.PLA.01.00



KIT TORCIA TH125
TH125 KIT TORCH

AC.KIT. T03721.PL105



PLASMA TORCH
TH125
CONSUMABLES



CO.52677
elettrodo
electrode



CO.60040
diffusore aria
swirl baffle



CO.51419
ugello
nozzle



CO.60309TC
porta ugello
nozzle holder



CO.51926
distanziale
spacer



PROCESSI / DUTY

Ciclo di lavoro Plasma • Plasma duty cycle	105 A – 40%
Corrente al 100 % • Plasma output at 100% duty cycle	65 A

INVERTER

Tensione di alimentazione • Mains voltage	3x400V-10+15%
Frequenza • Frequency	50/60Hz
Tensione a vuoto • OCV	450 V
Potenza nominale Plasma 100% • Plasma Nominal Power 100%	22,5 KW
Tensione d'arco plasma • Plasma arc voltage	170 V
Corrente max • Max current	38 A
Fusibile di protezione • Protective Fuses	time lag 40 A ritardato
Fattore di potenza • Power factor	0,85
Grado di protezione • Degree of protection	IP 23 S
Classe d'isolamento • Insulation Class	F
Temperatura ambiente • Working temperature	-10°C+40°C
Dimensioni (mm) • Size (mm)	610x230x460
Peso (Kg) • Weight (Kg)	32,00 Kg

FUNZIONI / FEATURES

Campo di regolazione Plasma • Plasma output range	30 – 105 A
Tipo innesco • Type of arc ignition	PILOT ARC NO HF

PRESTAZIONI / CUTTING PERFORMANCE

Divisione (mm) • Severance (mm)	38
Taglio qualità (mm) • Quality cut (mm)	32
Portata aria (lt/min) • Air flow (lt/min)	max 220
Pressione (bar) • Pressure (bar)	5,50

Ferro • Carbon steel \pm 32 mm



SINUS

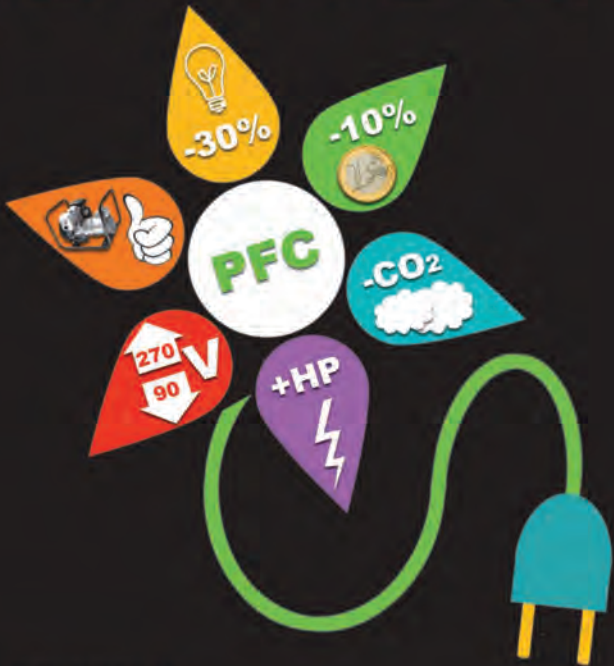

TECNOLOGIA PFC

Con la tecnologia PFC (Power Factor Corrector) si ottimizza l'assorbimento di corrente dalla rete. Grazie a questo dispositivo si riesce a sfruttare completamente la portata di corrente disponibile alla presa di alimentazione riuscendo ad erogare tutta la corrente di saldatura senza dispersioni di potenza.

PFC TECHNOLOGY

The PFC (Power Factor Corrector) technology helps enhancing the current draw from power supply and mains. Thanks to this technology, the mains fully available power is used and the output fully reflects the current draw without waist of current.

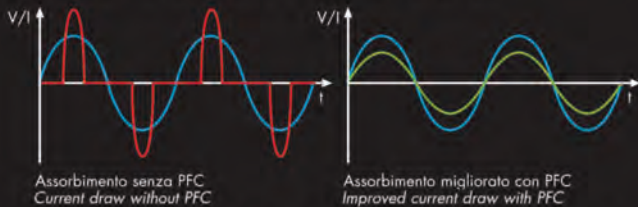

Il dispositivo PFC (Power Factor Corrector) va quindi a correggere la forma d'onda della corrente istante per istante eliminando i picchi e rendendola sinusoidale. Con il PFC si ottiene così un risparmio energetico sulla corrente assorbita pari al 30% salvaguardando l'ambiente.

The PFC (Power Factor Corrector) device is correcting the input current wave shape from a spike shaped to sinus shaped. With PFC we obtain an energy saving of the input current of about 30% and it's an environmental friendly technology.



Grazie alla tecnologia PFC (Power Factor Corrector) le cadute di tensione non sono più un problema, questo rende possibile l'utilizzo di cavi di alimentazione molto lunghi e di piccoli generatori di corrente.

Inoltre le macchine dotate di PFC (Power Factor Corrector) possono essere utilizzate in tutto il mondo senza doversi preoccupare delle diverse tensioni di rete.

Thanks to the PFC (Power Factor Corrector), current fluctuations are not a problem any longer and this allows for the use of very extensive power cables or small current generating sets. Moreover, the machines with PFC (Power Factor Corrector) can be used all over the world, no matter what mains input voltage is.

CHE COS'È IL PFC?

PFC è l'acronimo di Power Factor Corrector, cioè Correttore del Fattore di Potenza. Mentre i normali inverter assorbono la corrente a picchi utilizzando solo una parte della potenza disponibile, il dispositivo PFC (Power Factor Corrector) corregge la forma d'onda della corrente istante per istante eliminando i picchi e rendendola sinusoidale.

WHAT IS PFC?

PFC is the abbreviation of Power Factor Corrector which is, a control of the inverter's power. While all the inverters use the spikes of the power wave with non exploitation of the entire power, the PFC technology (Power Factor Corrector) is modifying the current's spikes in order to make it sinus-like.

I VANTAGGI DELLE MACCHINE ERGUS PFC THE ADVANTAGE OF ERGUS PFC

RISPARMIO ENERGETICO:

L'energia assorbita da un inverter si divide in POTENZA ATTIVA (circa 70%) e POTENZA REATTIVA (circa il 30%). La POTENZA ATTIVA è quella che realmente viene utilizzata, mentre la POTENZA REATTIVA genera perdite nella macchina e nella linea. Grazie al dispositivo ERGUS PFC (Power Factor Corrector) si eliminano gli sprechi dovuti alla POTENZA REATTIVA abbattendo di circa il 30% la corrente che circola in rete, con notevole risparmio di energia.

ENERGY SAVING:

The total energy input of an inverter is directed to ACTIVE POWER (about 70%) and REACTIVE POWER (about 30%). The ACTIVE POWER is really used, the REACTIVE POWER is lost in the inverter and the current lines. Thanks to ERGUS PFC (Power Factor Corrector), all waste of power due to REACTIVE POWER is saved, with a gain of 30% in energy saving.



RISPARMIO ECONOMICO:

Il risparmio della POTENZA REATTIVA ci solleva dal pagare al Gestore una penale sulla corrente consumata. Il risparmio in bolletta è circa del 10%.

ECONOMICALLY CORRECT:

Saving on the REACTIVE POWER will avoid us paying extra fees to the supplier of electricity the electricity bill will be lower by at least 10%.



RISPARMIO PER L'AMBIENTE:

Assorbendo il 30% in meno di corrente ci saranno minori perdite, quindi si dovrà usare meno combustibile per produrre la quantità di energia necessaria al nostro fabbisogno. Tutto questo si traduce in una minore produzione di Anidride Carbonica CO2, responsabile dell'effetto serra. Ad esempio utilizzando la nostra macchina SINUS 170/35 G-PROT risparmieremo circa 112kg/anno di CO2 al nostro pianeta!!!

ENVIRONMENTAL FRIENDLY:

By having 30% less input, the energy loss will decrease too, therefore the fuel necessary for a certain energy will be less. All this means a lower quantity of CO2 which is the main responsible for "green-house effect". For example, by using ERGUS SINUS 170/35 G-PROT we'll save about 112kg/year of CO2 on Earth!!!



MAGGIORE POTENZA DISPONIBILE:

Grazie al dispositivo ERGUS PFC (Power Factor Corrector) abbiamo un minore assorbimento di corrente di linea, possiamo quindi sfruttare tutta la potenza disponibile in rete. ERGUS PFC (Power Factor Corrector) permette di saldare elettrodi da 3,25 mm di diametro alimentando la macchina da una semplice presa di casa a 230V con una potenza installata di soli 3,3 kw.

MORE WELDING POWER AVAILABLE:

Thanks to ERGUS PFC (Power Factor Corrector) we have less current draw, consequently we can exploit all the available power from our mains. ERGUS PFC (Power Factor Corrector) allows welding electrodes dia 3,25 mm, plugging into the house mains 230V, having available 3,3 kw only.



ALIMENTAZIONE UNIVERSALE:

Il dispositivo ERGUS PFC (Power Factor Corrector) permette di alimentare la macchina, in modo automatico, con una tensione di rete da 90 fino a 270Volt, rendendola praticamente universale.

MULTI VOLTAGE INPUT:

ERGUS PFC (Power Factor Corrector) allows for a continuous input power with mains voltage from 90V to 270V, everywhere on earth.



COMPATIBILE CON TUTTI I MOTO-GENERATORI:

Tutte queste caratteristiche portano le macchine ERGUS PFC (Power Factor Corrector) ad essere protette "geneticamente" nell'uso con qualsiasi tipo di generatore di corrente sia stabilizzato che non stabilizzato. Inoltre, sfruttando tutta la potenza disponibile, possiamo utilizzare le macchine con sistema ERGUS PFC (Power Factor Corrector) anche con motogeneratori di piccola potenza.

ACCEPTS VOLTAGE INPUT FROM ALL THE GEN-SET:

Those features make ERGUS PFC (Power Factor Corrector) having a "DNA protection" if used with gen-sets, having either stabilized output or not. Moreover, the lower output power of small gen-sets can feed inverters ERGUS PFC (Power Factor Control).



NESSUN PROBLEMA DI PROLUNGHE:

Potendo funzionare fino a 90Volt, le cadute di tensione dovute alle prolunghe non sono più un problema. Le macchine dotate di ERGUS PFC (Power Factor Corrector) lavorano senza difficoltà con prolunghe fino a 250m ed una sezione cavo di soli 2,5mmq.

NO EXTENSION CABLE PROBLEMS:

Given the 90V input power from mains, the low voltage lines are not a problem. Our ERGUS PFC (Power Factor Corrector) accepts extension cables up to 250m and a section of only 2,5 sqmm.



PFC SINUS SERIES

150/50 G-PROT

PFF115.150.T-E.01.00



SINUS



International Welding Technologist
IWT
APPROVED



CE



PROCESSI / DUTY

Ciclo di lavoro TIG DC • TIG DC duty cycle	150 A – 60%
Corrente al 100 % • TIG DC output at 100% duty cycle	115 A
Ciclo di lavoro elettrodo • Electrode duty cycle	150 A – 50%
Corrente al 100 % • Electrode output at 100% duty cycle	105 A

INVERTER

Tensione di alimentazione • Mains voltage	90 – 270V
Frequenza • Frequency	50/60Hz
Tensione a vuoto • OCV	95 V
Potenza nominale elettrodo 100% • Electrode Nominal Power 100%	3,0 KW
Potenza nominale TIG DC 100% • TIG DC Nominal Power 100%	2,0 KW
Tensione d'arco elettrodo • Electrode arc voltage	20,2 – 26,0 V
Tensione d'arco TIG • TIG arc voltage	10,2 – 16,0 V
Corrente max • Max current	20 A
Fusibile di protezione • Protective Fuses	time lag 16 A ritardato
Fattore di potenza • Power factor	0,99
Grado di protezione • Degree of protection	IP 23 S
Classe d'isolamento • Insulation Class	F
Temperatura ambiente • Working temperature	-10°C+40°C
Dimensioni (mm) • Size (mm)	285x155x220
Peso (Kg) • Weight (Kg)	5,80

FUNZIONI / FEATURES

Campo di regolazione elettrodo • Electrode output range	5 – 150 A
Campo di regolazione TIG DC • TIG DC output range	5 – 150 A
Hot start • Hot start	Automatic
Arc force • Arc force	Automatic
Anti incollaggio • Antisticking	Automatic
Tipo innesco TIG DC • Type of arc ignition	LIFT ARC

*Tutti i dati tecnici sono riferiti ad una tensione di alimentazione di 230Vac
All the technical data here reported relate to input voltage 230Vac

PFC SINUS SERIES

170/35 G-PROT

PFF115.170.T-E.02.00



SINUS



International Welding Technologist
IWT
APPROVED



CE

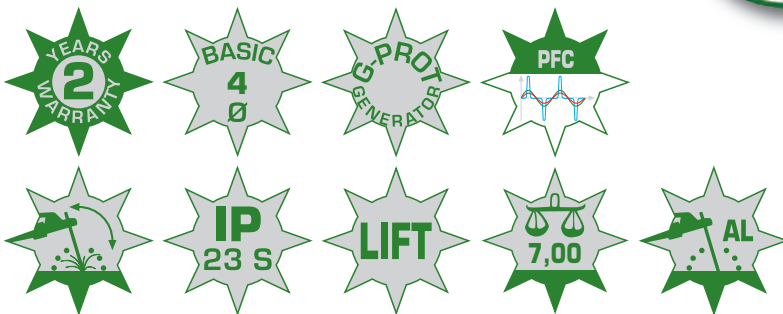

PROCESSI / DUTY

Ciclo di lavoro TIG DC • TIG DC duty cycle	170 A – 45%
Corrente al 100 % • TIG DC output at 100% duty cycle	130 A
Ciclo di lavoro elettrodo • Electrode duty cycle	170 A – 35%
Corrente al 100 % • Electrode output at 100% duty cycle	115 A

INVERTER

Tensione di alimentazione • Mains voltage	90 - 270V*
Frequenza • Frequency	50/60Hz
Tensione a vuoto • OCV	95 V
Potenza nominale elettrodo 100% • Electrode Nominal Power 100%	3,3 KW
Potenza nominale TIG DC 100% • TIG DC Nominal Power 100%	2,3 KW
Tensione d'arco elettrodo • Electrode arc voltage	20,2 – 26,8 V
Tensione d'arco TIG • TIG arc voltage	10,2 – 16,8 V
Corrente max • Max current	23 A
Fusibile di protezione • Protective Fuses	time lag 16 A ritardato
Fattore di potenza • Power factor	0,99
Grado di protezione • Degree of protection	IP 23 S
Classe d'isolamento • Insulation Class	F
Temperatura ambiente • Working temperature	-10°C+40°C
Dimensioni (mm) • Size (mm)	285x155x220
Peso (Kg) • Weight (Kg)	7,00

FUNZIONI / FEATURES

Campo di regolazione elettrodo • Electrode output range	5 – 170 A
Campo di regolazione TIG DC • TIG DC output range	5 – 170 A
Hot start • Hot start	Automatic
Arc force • Arc force	Automatic
Anti incollaggio • Antisticking	Automatic
Tipo innesco TIG DC • Type of arc ignition	LIFT ARC

*Tutti i dati tecnici sono riferiti ad una tensione di alimentazione di 230Vac

All the technical data here reported relate to input voltage 230Vac

PFC SINUS SERIES

WIG 170 HF DC

PFD115.170.T-E.01.00



SINUS



International Welding Technologist
IWT
APPROVED

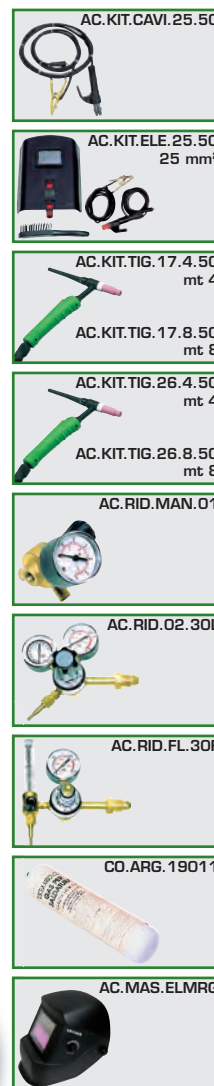

CE



PROCESSI / DUTY

Ciclo di lavoro TIG DC • TIG DC duty cycle	170 A – 45%
Corrente al 100 % • TIG DC output at 100% duty cycle	130 A
Ciclo di lavoro elettrodo • Electrode duty cycle	170 A – 35%
Corrente al 100 % • Electrode output at 100% duty cycle	115 A

INVERTER

Tensione di alimentazione • Mains voltage	90 – 270V
Frequenza • Frequency	50/60Hz
Tensione a vuoto • OCV	95 V
Potenza nominale elettrodo 100% • Electrode Nominal Power 100%	3,3 KW
Potenza nominale TIG DC 100% • TIG DC Nominal Power 100%	2,2 KW
Tensione d'arco elettrodo • Electrode arc voltage	20,2 – 26,8 V
Tensione d'arco TIG • TIG arc voltage	10,2 – 16,8 V
Corrente max • Max current	23 A
Fusibile di protezione • Protective Fuses	time lag 16 A ritardato
Fattore di potenza • Power factor	0,99
Grado di protezione • Degree of protection	IP 23 S
Classe d'isolamento • Insulation Class	F
Temperatura ambiente • Working temperature	-10°C+40°C
Dimensioni (mm) • Size (mm)	405x155x220
Peso (Kg) • Weight (Kg)	8,80

FUNZIONI / FEATURES

Campo di regolazione elettrodo • Electrode output range	5 – 170 A
Campo di regolazione TIG DC • TIG DC output range	5 – 170 A
Hot start • Hot start	Automatic
Arc force • Arc force	selezionabile/on/off option
Anti incollaggio • Antisticking	Automatic
Tipo innesco TIG DC • Type of arc ignition	HF/LIFT ARC
Comando consenso TIG • TIG DC control	2/4T - STEP
Corrente di base • Base current	5-100%
Regolazione tempo di salita • Slope up	0-20sec
Regolazione tempo di discesa • Slope down	0-20sec
Regolazione ritardo gas • Post gas	0,5-20sec
Corrente finale • End current	5-100%
Pulser • Pulser	SI / YES
Frequenza pulser • Pulser frequency	1-300 Hz
Memorie • Program Memories	3

*Tutti i dati tecnici sono riferiti ad una tensione di alimentazione di 230Vac
All the technical data here reported relate to input voltage 230Vac

PFC SINUS SERIES

PLASMA 35/40

PFF115.035.PLA.01.00



SINUS



CE



CONSUMABILI TORCIA PT-40
PLASMA TORCH PT-40 CONSUMABLES



PROCESSI / DUTY

Ciclo di lavoro Plasma • Plasma duty cycle	35 A – 40%
Corrente al 100 % • Plasma output at 100% duty cycle	22 A

INVERTER

Tensione di alimentazione • Mains voltage	230V±10%
Frequenza • Frequency	50/60Hz
Tensione a vuoto • OCV	270 V
Potenza nominale Plasma 100% • Plasma Nominal Power 100%	2,3 KW
Tensione d'arco plasma • Plasma arc voltage	82 V – 94 V
Corrente max • Max current	18 A
Fusibile di protezione • Protective Fuses	time lag 16 A ritardato
Fattore di potenza • Power factor	0,99
Grado di protezione • Degree of protection	IP 21 S
Classe d'isolamento • Insulation Class	F
Temperatura ambiente • Working temperature	-10°C+40°C
Dimensioni (mm) • Size (mm)	475x150x220
Peso (Kg) • Weight (Kg)	8,00

FUNZIONI / FEATURES

Campo di regolazione Plasma • Plasma output range	5 – 35 A
Tipo innesco • Type of arc ignition	PILOT ARC

PRESTAZIONI / CUTTING PERFORMANCE

Divisione (mm) • Severance (mm)	12
Taglio qualità (mm) • Quality cut (mm)	10
Portata aria (lt/min) • Air flow (lt/min)	max 100
Pressione (bar) • Pressure (bar)	3,5 - 4,0

Ferro • Carbon steel
10 mm



Espositore per punti vendita

Exhibition Stand for retail and fairs



COD. 0123410111

ERGUS INVERTERS

TE.C.I.A. srl

via Castel Morrone 15/C

16161 Genoa - Italy

phone +39.010.7450222

telefax +39.010.7406917

info@teclaitalia.com

www@teclaitalia.com



ERGUS in the World

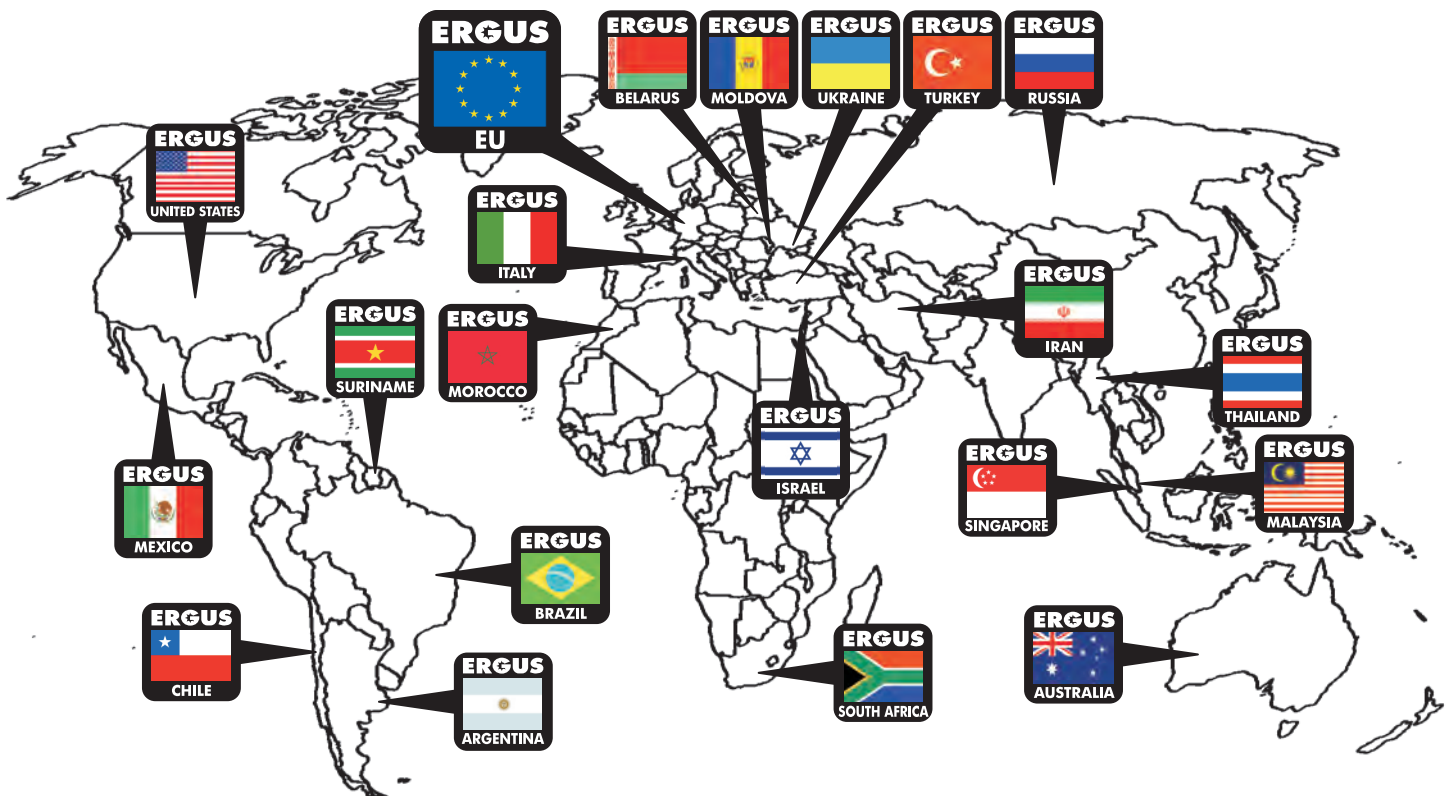

ERGUS
INVERTERS

QTECH CELL

SINUS

ERGUS INVERTERS

TE.C.LA. srl

via Castel Morrone 15/C

16161 Genoa - Italy

phone +39.010.7450222

telefax +39.010.7406917

info@teclaitalia.com

www@teclaitalia.com

